

Contenitori Universali



A complete collection of office storage units, with different dimensions and functions:

01/ 6 models of chests of drawers. **02/** 4 models of service units. **03/** 5 types of storage elements, movable units, smart cabinets, lockers, high cabinets, bookcases. **04/** Solid doors, glass doors, framed glass doors, sliding doors, micro-perforated metal doors. **05/** 2 wood finishes and 4 plain colours for the structure. **06/** 3 wood finishes and 5 plain colours for the doors. **07/** 2 finishes for aluminium frames. **08/** 9 finishes for micro-perforated metal doors. **09/** Upholstered cushions for chests of drawers and service storage units. **10/** Handles in matching finishing with doors. **11/** 3 types of cabinet locks.

Cassettiere
Chests of drawers
Jeux de tiroirs





Elementi studiati per conservare piccoli oggetti di uso corrente, in continuo movimento nello spazio operativo fino a diventare vere e proprie sedute. Cassettiere in numerose varianti funzionali ed estetiche cui spetta il ruolo di caratterizzare l'intera postazione.

Elements designed for storing small objects of everyday use, constantly being moved throughout the working area and ready to become handy seats. Drawers in different functional and aesthetic options, to characterise the entire workstation.

Eléments conçus pour ranger de petits objets d'usage quotidien, en mouvement continu dans toute la zone de travail pour devenir de véritables chaises. Tiroirs dans de nombreuses variantes fonctionnelles et esthétiques dont le rôle est de caractériser l'ensemble du poste de travail.



cod. 51

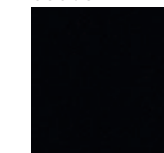

cod. 07



←
Ampi piani progettati per accogliere fotocopiatrici o computer.

Large tops designed to receive photocopiers or computers.

Des grands plateaux conçus pour recevoir les photocopieuses et les ordinateurs.





I contenitori sono progettati per garantire un abbinamento adeguato ad ogni collezione, operativa o direzionale. Linee sobrie, superfici pulite, ampia modularità. Un'impostazione progettuale che garantisce funzionalità e aumenta il livello estetico complessivo.

Storage units are designed to ensure adequate matching for each collection, operational or executive. Sober lines, clean surfaces, total modularity. A concept that ensures functionality and increases the overall aesthetic impact.

Les meubles de rangement sont conçus pour assurer une combinaison appropriée pour chaque collection, opérationnelle ou de direction. Lignes sobres, surfaces propres, grande modularité. Une approche de projet qui assure la fonctionnalité et augmente le niveau esthétique global.

cod.CP 01 cod.44

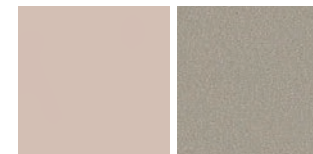

cod.68 cod.03



←
Maniglie a ponte in identica finitura delle ante.
Bridge-shaped handles in matching finishing with doors.
Poignées à pont dans la même finition des portes.



I contenitori Smart nascono dalla volontà di attrezzare le postazioni in modo libero e funzionale rispettando le più varie esigenze del cliente. La stretta modularità e la variabilità tipologica consentono di ottenere composizioni articolate e complete.

Smart storage units are the response to the need for freely and functionally equipped workstations that can meet any need. The high modularity and the many typologies allow the creation of complex and complete layouts.

Les rangements « Smart » sont le résultat de la volonté d'équiper les postes de travail de manière libre et fonctionnelle en respectant les besoins les plus diverses des clients. La précision de la modularité et la variabilité des typologies permettent d'obtenir des compositions articulées et complètes.

>
A lato scrivania, la componibilità consente usi differenziati sui due lati.
On the desk side, the modularity allows different uses on the two sides.
Sur le côté du bureau, la modularité permet des usages différents sur les deux faces.



cod. 38



cod. NR 03

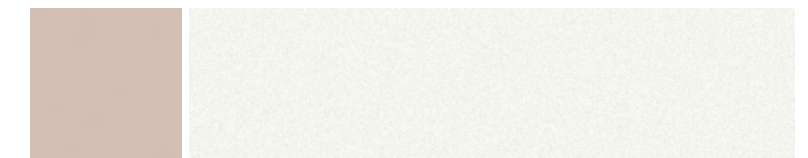

cod. CP 01 cod. 68



cod. 68

cod. 03

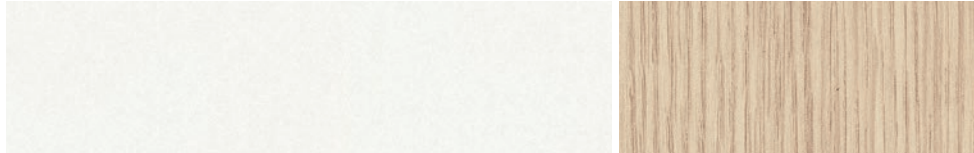

Contenitori modulari con schienali e fianchi rialzati per delimitare maggiormente il top e accogliere gli accessori metallici porta oggetti.

Modular containers with raised backs and sides that outline the worktop more clearly and receive the metal accessories for objects.

Rangements modulaires avec dos et côtés qui dépassent en hauteur définissent nettement le plateau et reçoivent les accessoires porte-objets en métal.

↑
Contenitori a giorno in altezza di scrivanie con schiena e fianchi rialzati.
Open containers at desk height with raised back and sides.
Rangements ouverts à la hauteur du bureau avec dos et côtés plus hauts.

cod. GL 01





cod. CP 01



→ Anta metallica microforata in colore nero e maniglia a ponte in tinta.
 Micro-perforated black metal door and bridge-shaped handle in matching colour.
 Porte en métal noir micro-perforé et poignée à pont en couleur.



Contenitori in cui si alternano vani a giorno e ante in metallo microforate, elementi adeguati ad ogni ambiente, operativo o direzionale.

Storage units that alternate open shelves and cabinets with micro-perforated metal doors that can suit any environment, operational or executive.

Rangements qui alternent les compartiments ouverts et les portes en métal micro-perforées, éléments adaptés à n'importe quel environnement, opérationnel ou exécutif.

cod. NR 03

cod. 51



cod. 68

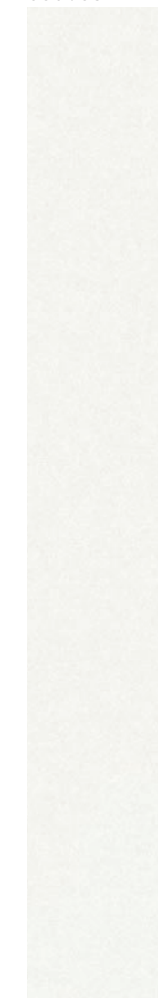



I contenitori universali superano il loro valore strettamente funzionale e diventano elementi estetici determinanti all'interno di ogni ufficio. Sono vere e proprie quinte che articolano lo scenario dell'ambiente di lavoro mediante le loro numerose finiture.

Universal storage units go beyond their strictly functional value and become aesthetic elements of high impact in any office environment. These are real scenes that articulate the scenario of the working environment with their many finishes.

Les rangements universels vont au-delà de leur valeur strictement fonctionnelle et deviennent des éléments esthétiques décisifs dans chaque bureau. Ce sont des vraies scènes qui articulent le scénario de l'environnement de travail grâce à leurs nombreuses finitions.



cod.03



→ Particolare della cerniera ammortizzata.
Detail of soft-closing hinge.
Détail de la charnière avec amortissement.

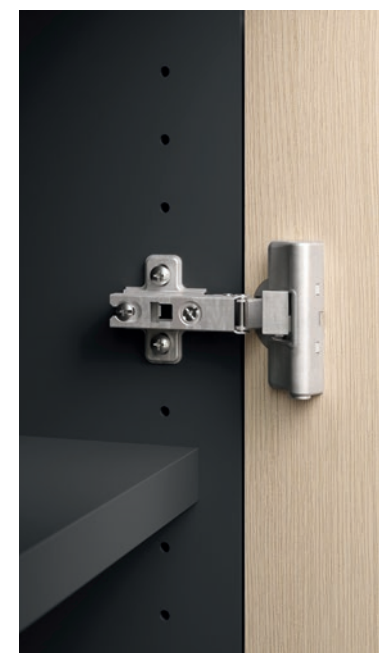



Librerie a spalla portante ideali per l'archiviazione massiva o per realizzare giochi di pieni e di vuoti in cui libri, riviste e oggetti si alternano scenograficamente. Contenuti estetici e culturali si avvicinano per arredare archivi, sale riunioni o spazi di rappresentanza.

Bibliothèques autoportées idéales pour un archivage important ou pour créer des jeux de pleins et de vides où les livres, les magazines et les objets s'alternent scénographiquement. Les contenus esthétiques et culturels communiquent pour meubler des archives, des salles de réunion ou des espaces représentatifs.

→ Bussolotti a giorno o con ante proposti in quattro finiture.
Open square shelves or with doors available in four finishes.
Étagères ouvertes ou avec portes disponibles en quatre finitions.

Free-standing bookcases perfect for filing or to play with empty and full volumes where books magazines and objects alternate scenographically. Aesthetic and cultural content communicate to furnish filing rooms, meeting rooms or representative spaces.



cod. 63

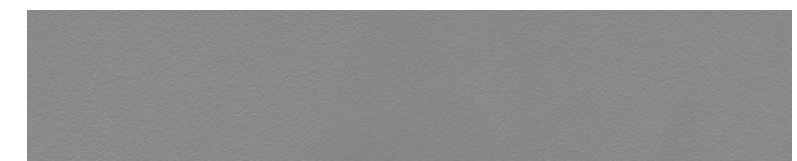

cod. 38



Il telaio in colore nero e la piccola maniglia a ponte evidenziano le alternanze delle ante vetrate e di quelle in legno, secondo schemi compositivi pensati per elevare il livello estetico del contenitore. La cornice, netta e decisa, valorizza ogni elemento dando un carattere nuovo.

The black frame and the small bridge-shaped handle enhance the alternation of glass and wooden doors, following composition schemes designed to improve the storage unit aesthetic level. The clear and neat frame enhances each individual element giving it a new personality.

Le cadre noir et la petite poignée à pont soulignent l'alternance des portes en verre et en bois, selon des schémas de composition conçus pour augmenter le niveau esthétique du rangement. Les lignes claires et décisives mettent en valeur chaque élément en lui donnant un nouveau caractère.

→
 Basamento
 metallico per
 contenitori
 bassi, medi e
 alti.
 Metal base for
 low, medium-
 height and high
 containers.
 Base en métal
 pour meubles bas,
 moyens et hauts.



cod.07

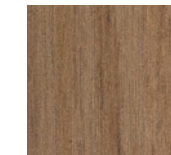

cod.68

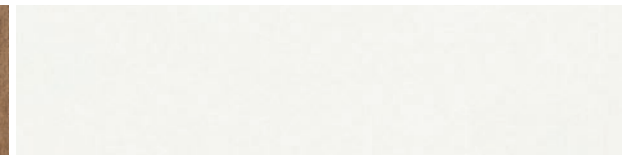

Lockers





← Anta con serratura elettronica, scheda master e chiave di sicurezza.
 Doors with electronic lock, master card and safety key.
 Porte avec serrure électronique, carte master et clé de sécurité.



cod. 07

L'ufficio agile si struttura per accogliere un'operatività dinamica e in continua comunicazione tra esterno e interno. I contenitori guardaroba, in cui conservare effetti personali o capi d'abbigliamento, si integrano pienamente nello spazio operativo.

The agile office is organised to welcome dynamic operations in constant communication between the outside and inside environments. Wardrobe containers for the storage of personal belongings or clothing are fully integrated into the operational space.

Le bureau agile est structuré pour permettre des opérations dynamiques avec communication continue entre l'extérieur et l'intérieur. Les rangements armoire, dans lesquels ranger les effets personnels ou les vêtements, sont entièrement intégrés dans l'espace opérationnel.

cod. 38

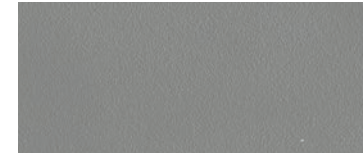

cod. 56



←
 Lockers ad ante
 cieche con
 serratura a
 combinazione.
 Lockers and
 solid doors with
 combination lock.
 Casiers à portes
 en bois avec
 serrure à
 combinaison.

Lo spazio operativo si arricchisce di contenitori nomadi con ruote, dotati di ante e cassetti, capaci di fornire una efficace risposta alla continua richiesta di flessibilità operativa e di mobilità interna alle aree di lavoro. Elementi adatti ad ogni ambiente.

The operational space is enriched with movable containers on castors, fitted with doors and drawers, that provide an effective response to the increasing need for operational flexibility and internal mobility in the work environments. Elements that suit any environment.

L'espace opérationnel s'enrichit avec des rangements amovibles sur roues, équipés de portes et de tiroirs, pour répondre efficacement à la demande continue de flexibilité opérationnelle et de mobilité dans les zones de travail. Élément appropriés dans tous les environnements.

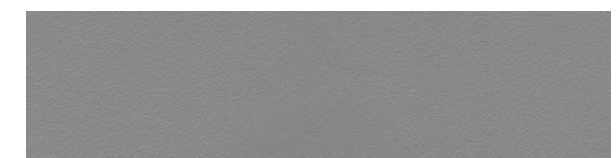

cod . 38



Mobili su ruote
Cabinets on wheels | Caissons sur roules

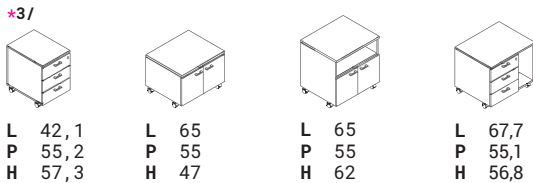

Mobili di servizio su piedini
Service units on feet | Porte-photocopieur et meubles de service

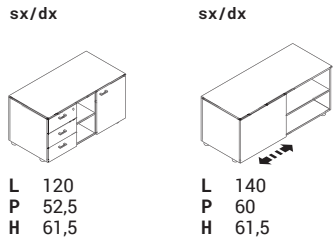

Mobili
Cabinets | Meubles

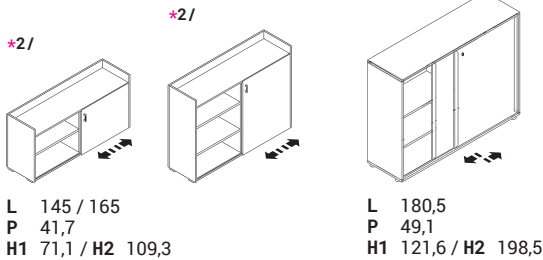
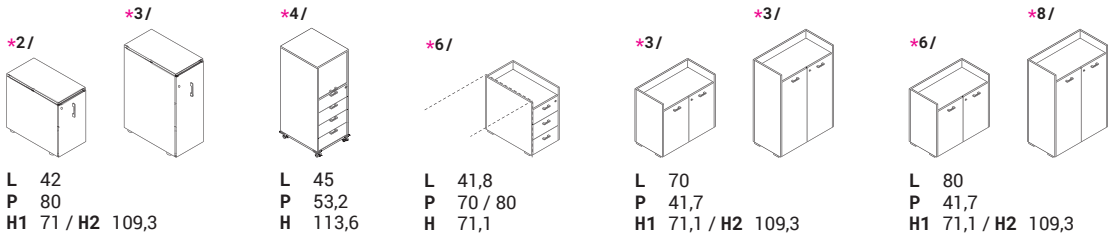

Contenitori
Cabinets | Meubles

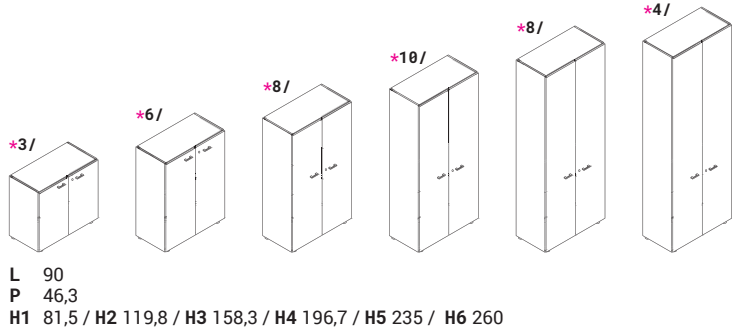
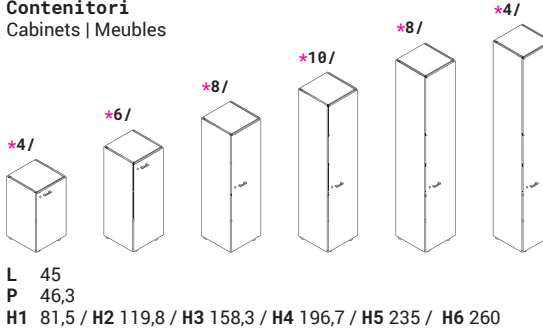

Lockers
Lockers | Lockers

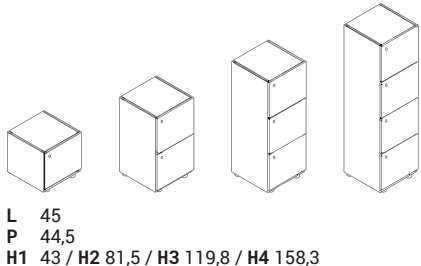

* configurazioni possibili | possible configurations | possibles configurations

CARTELLA COLORI
colours samples card

**QUESTA SERIE DI CONTENITORI UNIVERSALI EVO E' STATA CREATA PER ESSERE INTEGRATA
CON TUTTA LA GAMMA PRODOTTI LAS MOBILI GRAZIE AI COLORI CHE PERMETTONO QUALSIASI ABBINAMENTO**
*THIS RANGE OF UNIVERSAL CABINETS EVO HAS BEEN MADE TO BE COMBINED
WITH ALL LAS MOBILI PRODUCT, THANKS TO THE COLOURS THAT ALLOW ANY MATCHING*



COD. 03 ○
ROVERE | OAK



COD. 44 ○
STONE GREY | STONE GREY



COD. 07 ○
NOCE CLASSICO | CLASSIC WALNUT



COD. 51 ○
NERO | BLACK



COD. 20 ○
MUSCHIO | MOSS GREEN



COD. 63 ○
PIOPPO MORO | DARK POPLAR



COD. 38 ○
GRIGIO | GREY

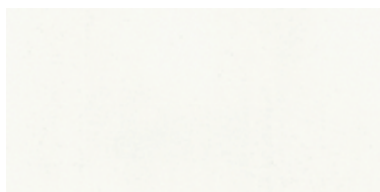

COD. 68 ○
BIANCO | WHITE

ANTE VETRO
glass doors



COD. 99
BIANCO SATINATO | SATINED WHITE

SMART CABINETS
ANTE IN METALLO
metal doors

COLORI STANDARD
standard colours



COD. AR 02
ARGENTO | SILVER

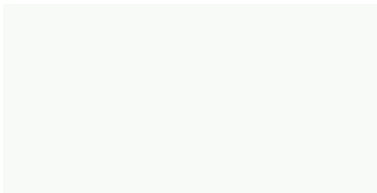

COD. BI 02 (RAL 9016)
BIANCO | WHITE



COD. SG 01
STONE GREY | STONE GREY



COD. VR 01
MUSCHIO | MOSS GREEN

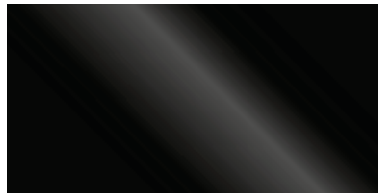

COD. NR 03
NERO (OPACO) | (MATT) BLACK

COLORI PASTELLO
pastel colours

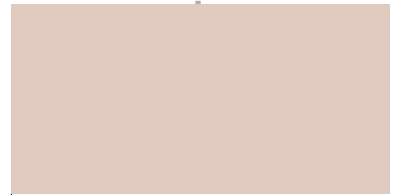

COD. CP 01 (Pantone 4755 C)
CIPRIA | POWDER PINK



COD. GL 01 (Pantone 600 C)
GIALLO | YELLOW



COD. VR 02 (Pantone 4178 C)
VERDE | GREEN



COD. CL 01 (Pantone 545 C)
CELESTE | LIGHT BLUE

ABACO ALTEZZE E CONFIGURAZIONI MOBILI CONTENITORI

abacus of height and configuration of cabinets

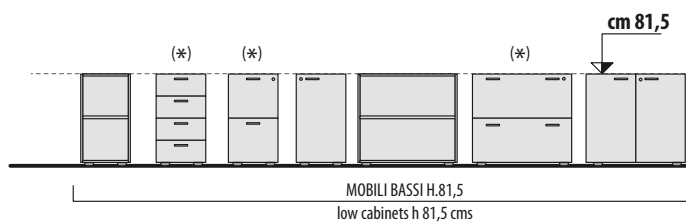

STRUTTURE METALLICHE PER
MOBILI FREESTANDING
metallic structure for
freestanding cabinets
H 81,5-119,8-158,3-196,7

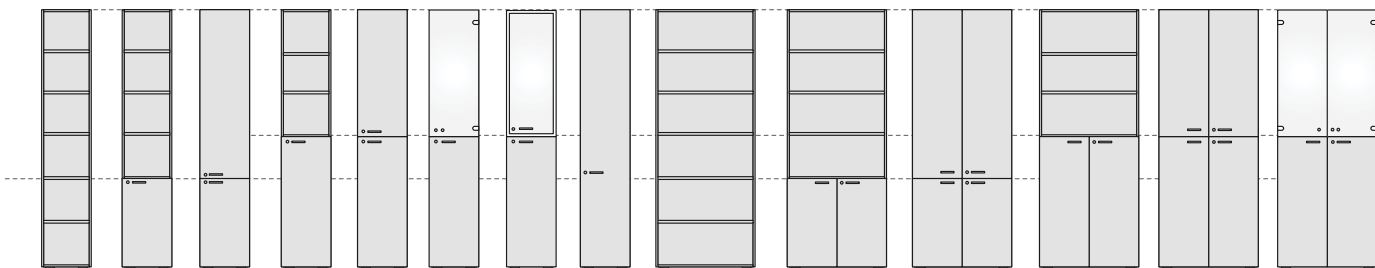
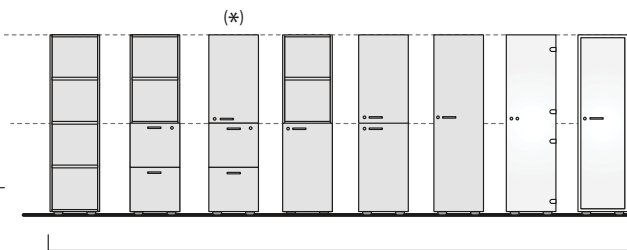
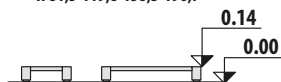

MOBILI ALTI H.235 (kit fissaggio a muro incluso)
high cabinets h 235 cms (wall fixing kit included)

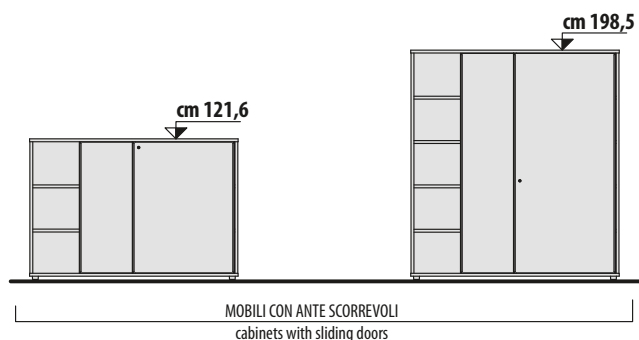

(*)=CONFIGURAZIONI NON POSSIBILI PER MOBILI PROF. CM 35
 configurations don't availables for cabinets deep 35 cms

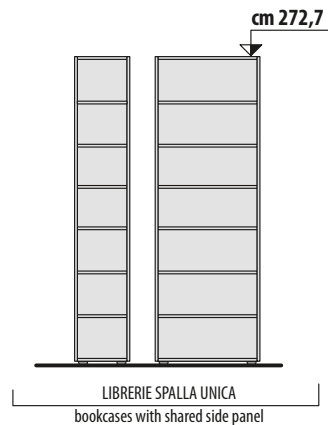
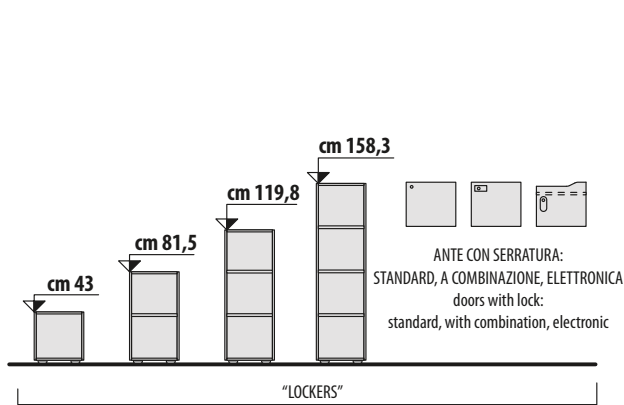
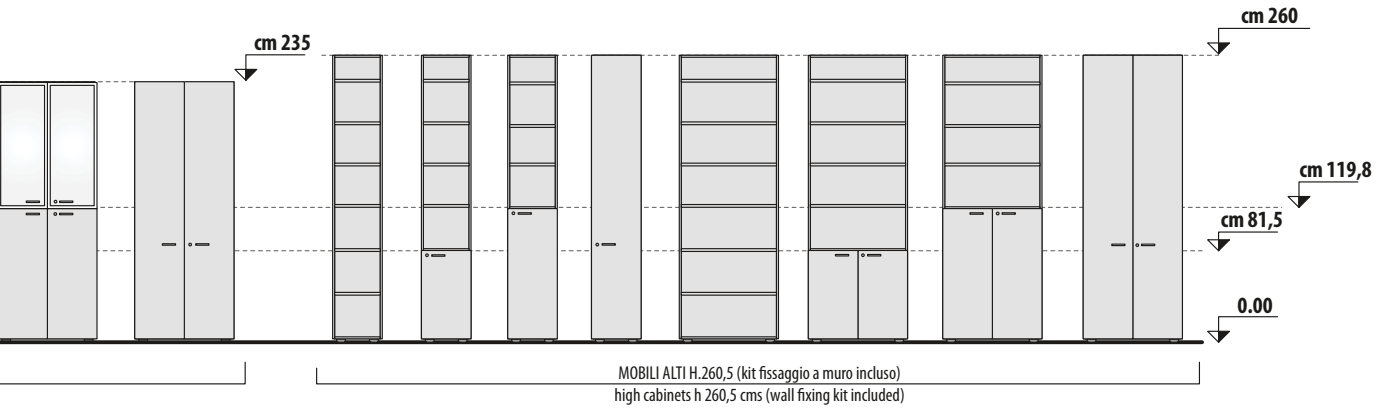
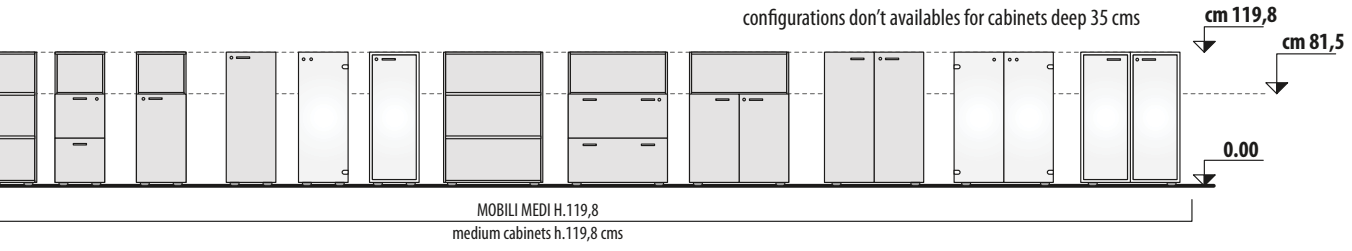

ESEMPI DI AGGREGAZIONE LIBRERIE SPALLA UNICA

examples of connection bookcases with shared side panel

LEGENDA	
key list	
A	MODULO TERMINALE (CON 2 FIANCHI FINALI) terminal module (with 2 final side panels)
B	MODULO CENTRALE (CON FIANCO INTERMEDIO) central module (with central panel)

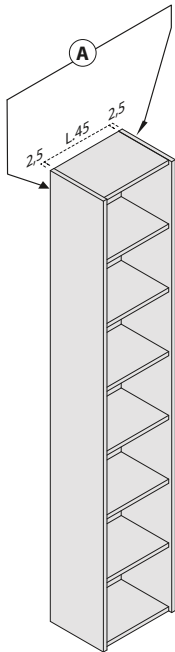

POSIZIONARE I 2 FIANCHI FINALI ALLE DUE ESTREMITÀ DELLA COMPOSIZIONE
place the 2 final side panels at the two extremities of the composition

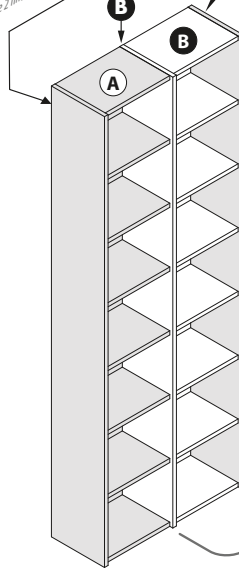

n...moduli centrali
n...central modules

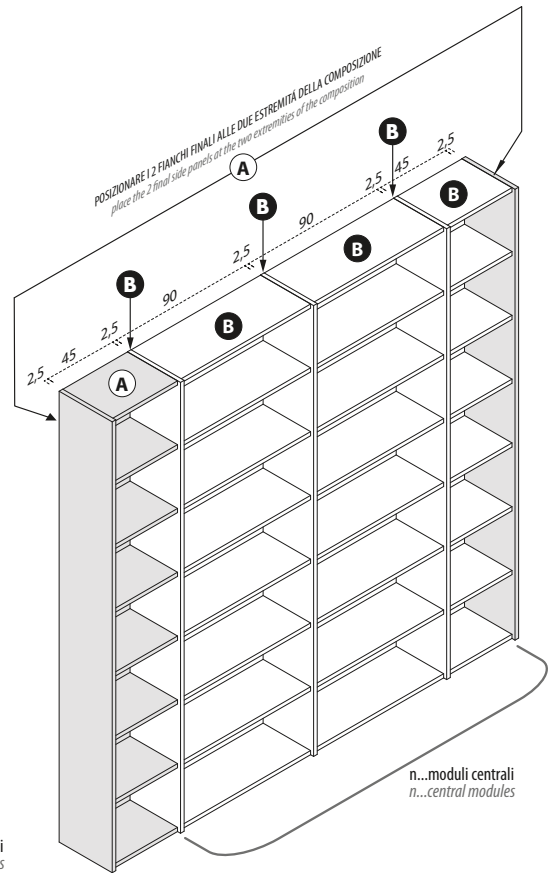

n...moduli centrali
n...central modules

ESEMPIO DI COMBINAZIONI MOBILI SPALLA UNICA CON ANTE ART.924 E BUSSOLOTTI ART.954

Examples of combination bookcases with doors ART.924 and modular unit ART.954

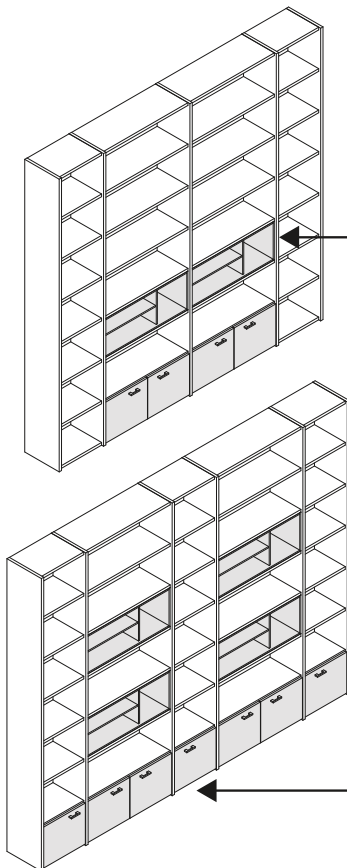

cm 272,7

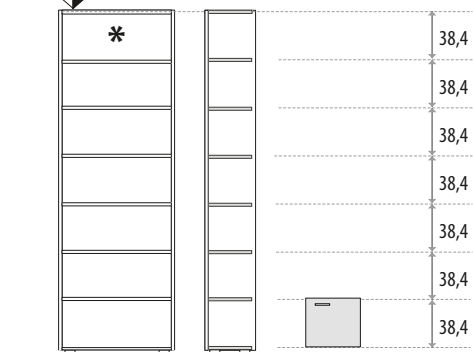

* ante intere non disponibili
whole doors not available

per 1
VANO
for 1
close space



ANTE POSIZIONABILI SOLO IN BASSO
doors can be positioned only at the bottom
(single or combined use)

ABACO CASSETTIERE, MOBILI, STORAGE, NOMADI

abacus of pedestals, muebles, storage, nomads

CUSCINO (optional)
cushion (optional)

CUSCINO (optional)
cushion (optional)

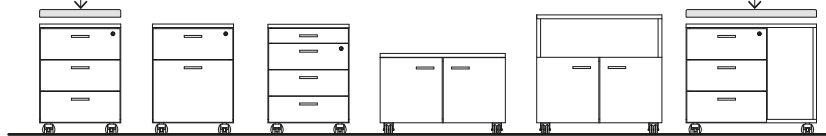

CASSETTIERE E MOBILI SU RUOTE
pedestals and cabinets on wheels

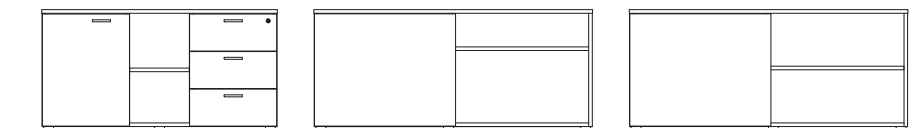

MOBILI DI SERVIZIO SU PIEDINI
service units on feet

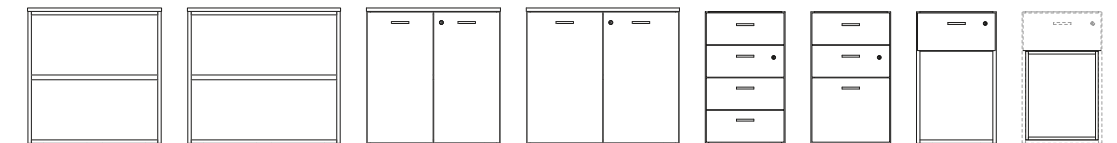

MOBILI E CASSETTIERE LATERALI CON TOP DI FINITURA SINGOLO O DOPPIO
lateral cabinets and pedestals with single or double finish top

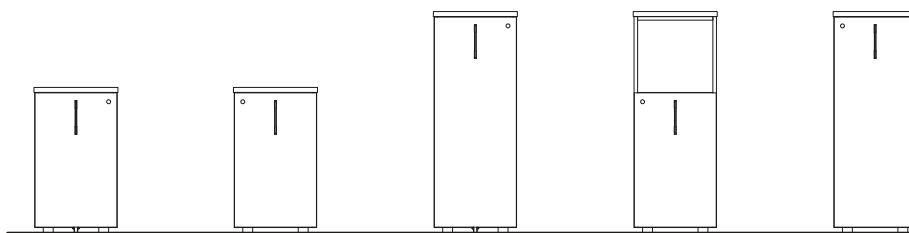

STORAGE CON TOP DI FINITURA SINGOLO O DOPPIO
storage with single or double finish top

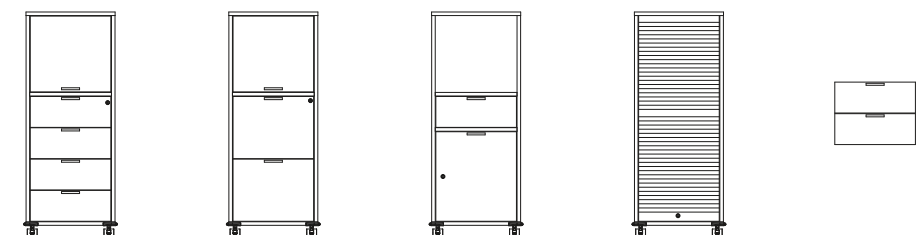

MOBILI NOMADI
nomads cabinets

ABACO SMART CABINETS

abacus of smart cabinets

**TUTTI GLI SMART OFFICE SI POSSONO UTILIZZARE IN ACCOSTAMENTO A SCRIVANIE
OPPURE COME FREESTANDING**

all smart cabinets can be used in combination with desks
or as a freestanding

