

JERA ENOSI E.O.S. IULIO ELITE
DELTA FIL ROUGE 5th ELEMENT
OXI UP SCHERMI PIEGO CHIUDO
SEGUO SHARE CUBO PRONTO
CONTENITORI UNIVERSALI
I-MEET **NICE POINT** JAVA PAUSA
CONVIVIO FUNGO SEGNO
ICARO REGOLO KYOTO PODIO
LEAD JERA SCENA NEOCHAIR
TRAMA ATHENA FORMEN
GALASSIA DOLLY STAR SISTEMA
CAST CIAK PRIMA RASSEGNA
ESSAI HELLÒ OSCAR BROADWAY
F01 F02 F03 F04 F05 REGIA
VEDETTE FICTION TROUPE
ZOOM SUPEROTTO PROVINO
SELLO F01 BENCH F03 BENCH
MOVIE TRUKA JERA24 FESTIVAL
JETSET JERA22 TREND SET22
DOMUS DRIVE IN DIVO FLAGS
TRAILER WORKLAND

Point



The Point reception desk is inspired to formal rigour criteria declined in versatile modules that can be combined together. The simplicity in the composition and its minimal style generate infinite combinations, with different shapes and sizes, that can be adapted to any context.

cod. 31



→
Fianco strutturale
che chiude
lateralmente ogni
modulo.
Side structural
element the
literally closes
each module.
Côté structurel
qui ferme
chaque module
latéralement.





The simplest and the smallest modules provide the same features and functionality as the most complex compositions. Different worktops for guests and operators, clearly distinguishable by their height.

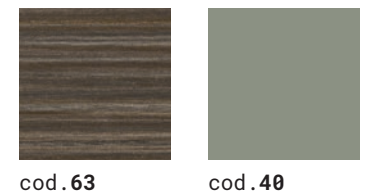

→ Piano di ricevimento per ospiti disabili.
 Reception worktop for disabled guests.
 Plan d'accueil pour personnes à mobilité réduite.

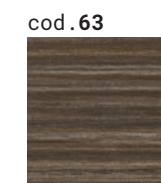



The chromatic and material effect of metal shelves adds value to the reception counter through the evolution of the original linearity of this project.

→
 Il ridotto spessore della lamiera enfatizza il pannello strutturale in legno.
 The reduced thickness of the metal sheet highlights the structural wooden panel.
 L'épaisseur réduite de la tôle souligne le panneau structurel en bois.



cod. VR 02



→
 Mensole lineari in acciaio verniciato in nove colori.
 Linear shelves in painted steel, available in nine colours.
 Étagères linéaires en acier peint en neuf couleurs.



Reception
Reception | Réception

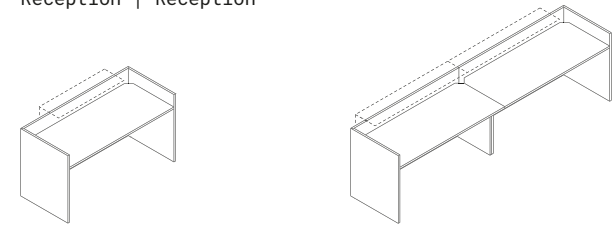

L 125 / 145 / 165 / 185
P 72,5
H 105

L 245 / 285 / 325 / 365
P 72,5
H 105

Moduli
Modules | Modules

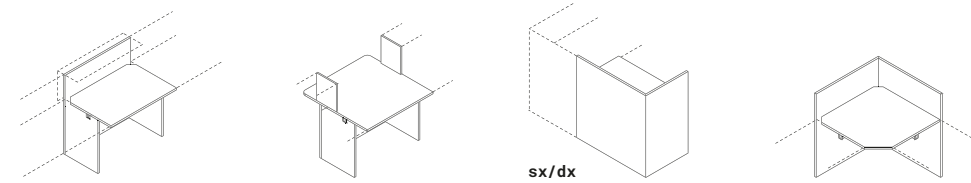

L 100
P 72,5
H 105

L 100
P 100
H 105

sx/dx
L 102,5
P 62,5
H 105

L 92,5
P 92,5
H 105



sx/dx
L 122,5 / 142,5 / 162,5 / 182,5
P 72,5
H 105

sx/dx
L 122,5
P 122,5
H 105

Mensole
Shelves | Etageres

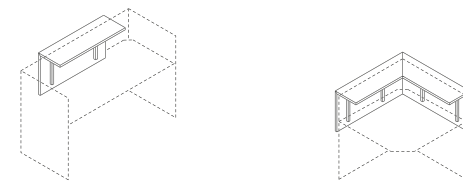

L 100 / 120 / 140 / 160
P 30
H 50

L 97,5 - 97,5
P 30
H 50

Cattedre
Conference desks | Bureaux conference

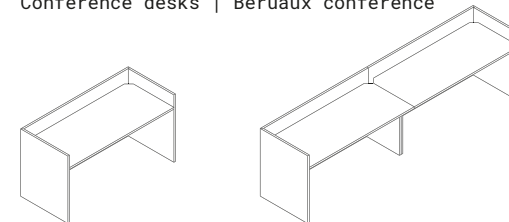

L 165
P 72,5
H 90

L 325
P 72,5
H 90

RECEPTION, ALLUNGHI, CATTEDRE

reception, extension, desks



COD. 03
ROVERE | OAK



COD. 38
GRIGIO | GREY



COD. 63
PIOPPO MORO | DARK POPLAR



COD. 07
NOCE CLASSICO | CLASSIC WALNUT



COD. 44
STONE GREY | STONE GREY

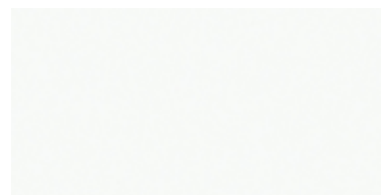

COD. 68
BIANCO | WHITE



COD. 31
ROVERE NIAGARA | NIAGARA OAK

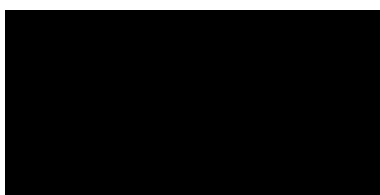

COD. 59
NERO | BLACK

MENSOLE LEGNO

wooden shelves



COD. 03
ROVERE | OAK



COD. 38
GRIGIO | GREY



COD. 59
NERO | BLACK



COD. 07
NOCE CLASSICO | CLASSIC WALNUT



COD. 39
ROSSO GRANATO | GRANADE RED



COD. 63
PIOPPO MORO | DARK POPLAR



COD. 09
ROVERE NATURALE | NATURAL OAK



COD. 40
SALVIA | SAGE GREEN



COD. 64
PIOPPO LIGHT | LIGHT POPLAR

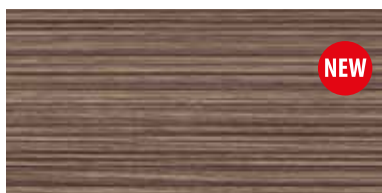

COD. 13
NOCE MODERNO | MODERN WALNUT



COD. 41
BLU NEBBIA | MISTY BLUE

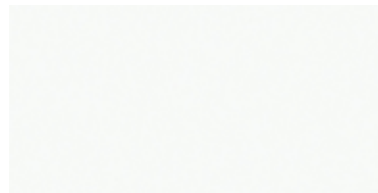

COD. 68
BIANCO | WHITE



COD. 20
MUSCHIO | MOSS GREEN



COD. 44
STONE GREY | STONE GREY



COD. 31
ROVERE NIAGARA | NIAGARA OAK

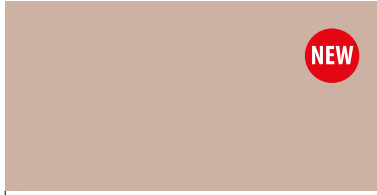

COD. 46
ROSA ANTICO | ANTIQUE PINK

MENSOLE IN METALLO
metal shelves



COD. AR 02
ARGENTO | SILVER



COD. SG 01
STONE GREY | STONE GREY



COD. AV 02
AVIO | NAVY BLUE

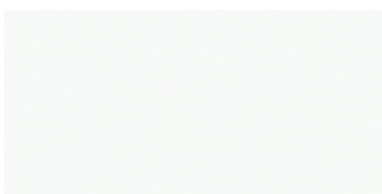

COD. BI 02 (RAL 9016)
BIANCO | WHITE

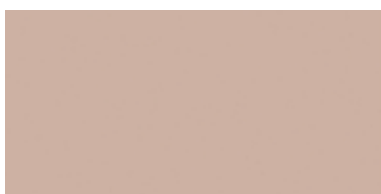

COD. CP 01
CIPRIA | POWDER PINK



COD. VR 01
MUSCHIO | MOSS GREEN

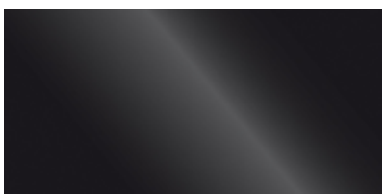

COD. NR 03
NERO (OPACO) | (MATT) BLACK



COD. VR 02
VERDE | GREEN



COD. RS 02 (RAL 3005)
ROSSO GRANATO | GRANADE RED

ESEMPI DI COMPONENTABILITA'

examples of compositions

RECEPTION LINEARE SINGOLA single linear reception

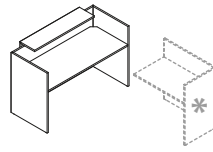

ART.013+045

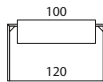

ART.014+045

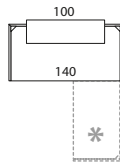

ART.019+046

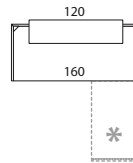

ART.020+047

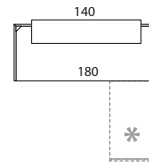

- VISTE IN PIANTA -
- Top view -

* = POSSIBILITA' DI UTILIZZO ALLUNGO RECEPTION DX O SX
= Possibility to use the right or left extension reception

RECEPTION LINEARE DOPPIA double linear reception

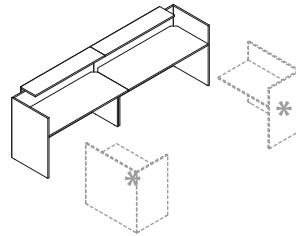

1 ART.022 + 2 ART.045

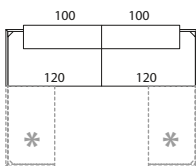

1 ART.023 + 2 ART.046

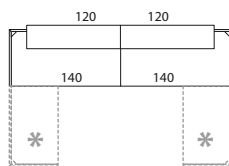

1 ART.024 + 2 ART.047

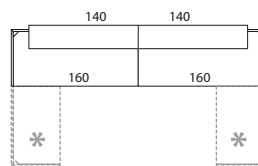

1 ART.025 + 2 ART.048

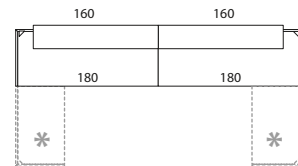

RECEPTION LINEARE CON MODULO PROLUNGA CENTRALE linear reception with central module

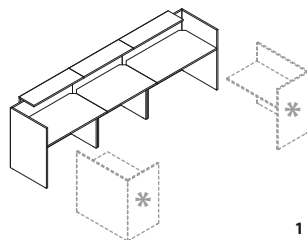

1 ART.022 + 1 ART.027 + 3 ART.045

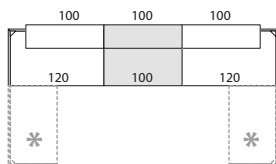

1 ART.023 + 1 ART.027 + 1 ART.045 + 2 ART.046

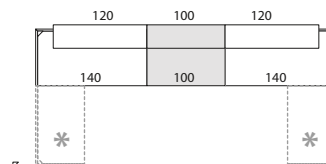

1 ART.024 + 1 ART.027 + 1 ART.045 + 2 ART.047

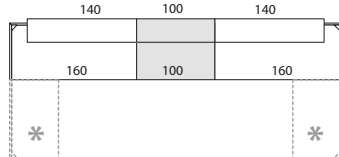

1 ART.025 + 1 ART.027 + 1 ART.045 + 2 ART.048

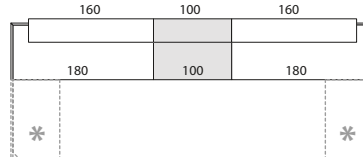

ESEMPI DI COMPONENTABILITA'

examples of compositions

RECEPTION TERMINALI
CON ANGOLO, PROLUNGA CENTRALE E MODULI CONVERSAZIONE
terminal reception with corner, central module and conversation modules

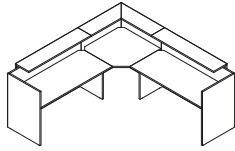

ART.054-055-056-057+
ART.045-046-047-048+
LED ART.060-061-062-063

ART.049+
ART.066+
LED ART.064

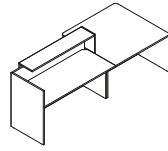
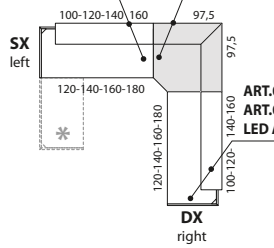

ART.054-055-056-057+
ART.045-046-047-048+
LED ART.060-061-062-063

ART.058-069

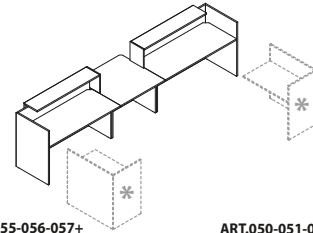
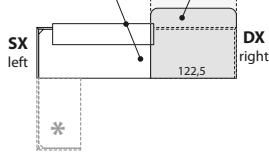

ART.054-055-056-057+
ART.045-046-047-048+
LED ART.060-061-062-063

ART.028

ART.050-051-052-053+
ART.045-046-047-048+
LED ART.060-061-062-063

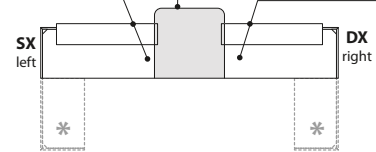

* = SU TUTTE LE RECEPTION TERMINALI C'E
POSSIBILITA' DI UTILIZZO ALLUNGO RECEPTION DX O SX
= Possibility to use the right or left extension with
all terminal reception

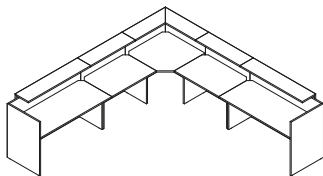

ART.054-055-056-057+
ART.045-046-047-048+
LED ART.060-061-062-063

ART.027+
ART.045+
LED ART.060

ART.049+
ART.066+
LED ART.064

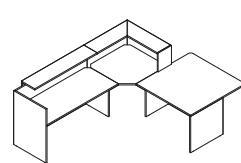
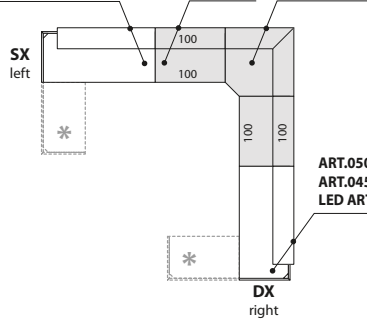

ART.054-055-056-057+
ART.045-046-047-048+
LED ART.060-061-062-063

ART.049+
ART.066+
LED ART.064

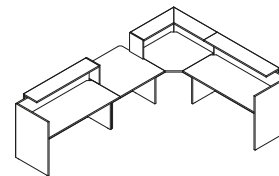
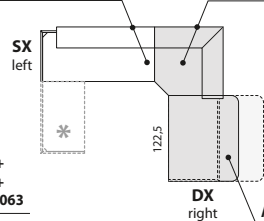

ART.054-055-056-057+
ART.045-046-047-048+
LED ART.060-061-062-063

ART.028

ART.049+
ART.066+
LED ART.064

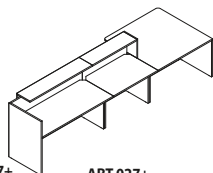
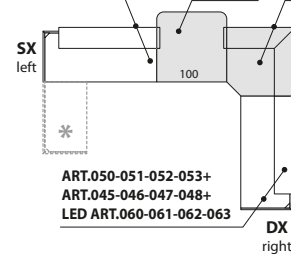

ART.054-055-056-057+
ART.045-046-047-048+
LED ART.060-061-062-063

ART.027+
ART.045+
LED ART.060

ART.058-069

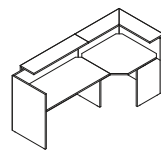
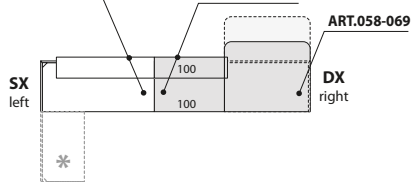

ART.054-055-056-057+
ART.045-046-047-048+
LED ART.060-061-062-063

ART.049+
ART.066+
LED ART.064

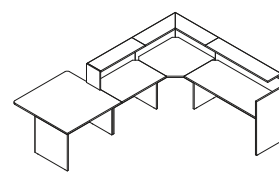
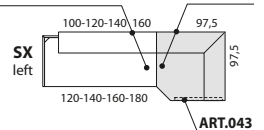

ART.059-070

ART.027+
ART.045+
LED ART.060

ART.049+
ART.066+
LED ART.064

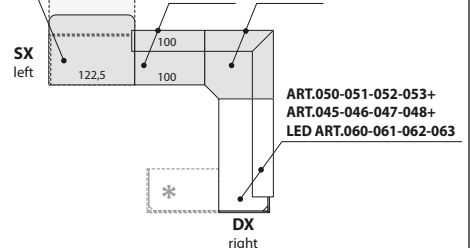

DIMENSIONI
dimensions

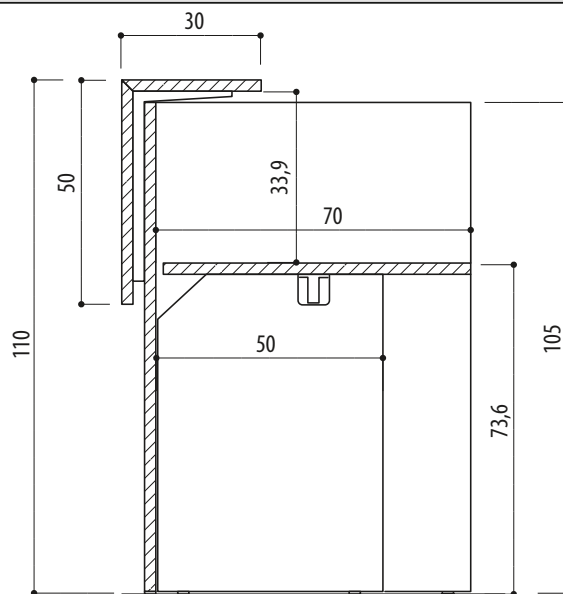

SEZIONE VERTICALE
MODULI RECEPTION
vertical section of
reception modules

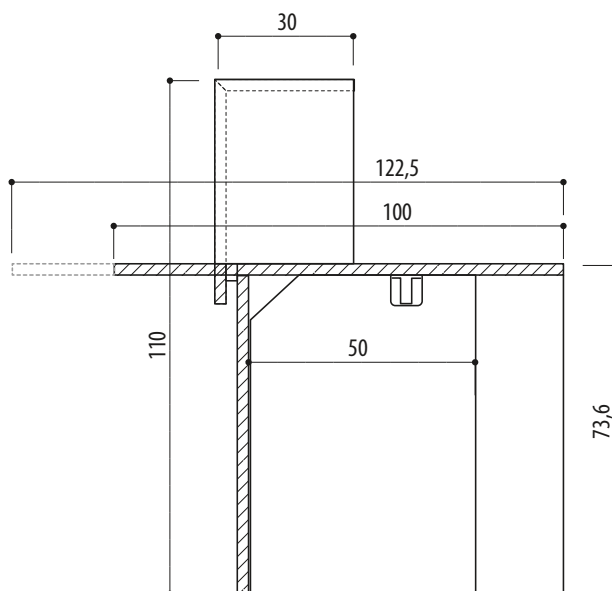

SEZIONE VERTICALE
MODULI CONVERSAZIONE
vertical section of
conversation modules

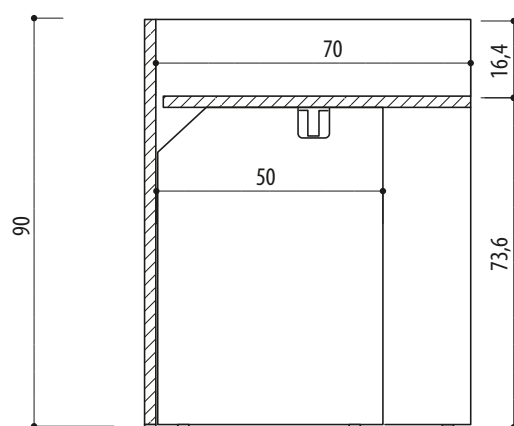

SEZIONE VERTICALE
CATTEDRE
vertical section of
conference desks