

/ outline

design:
Gianantonio Perin
Monica Fernandes

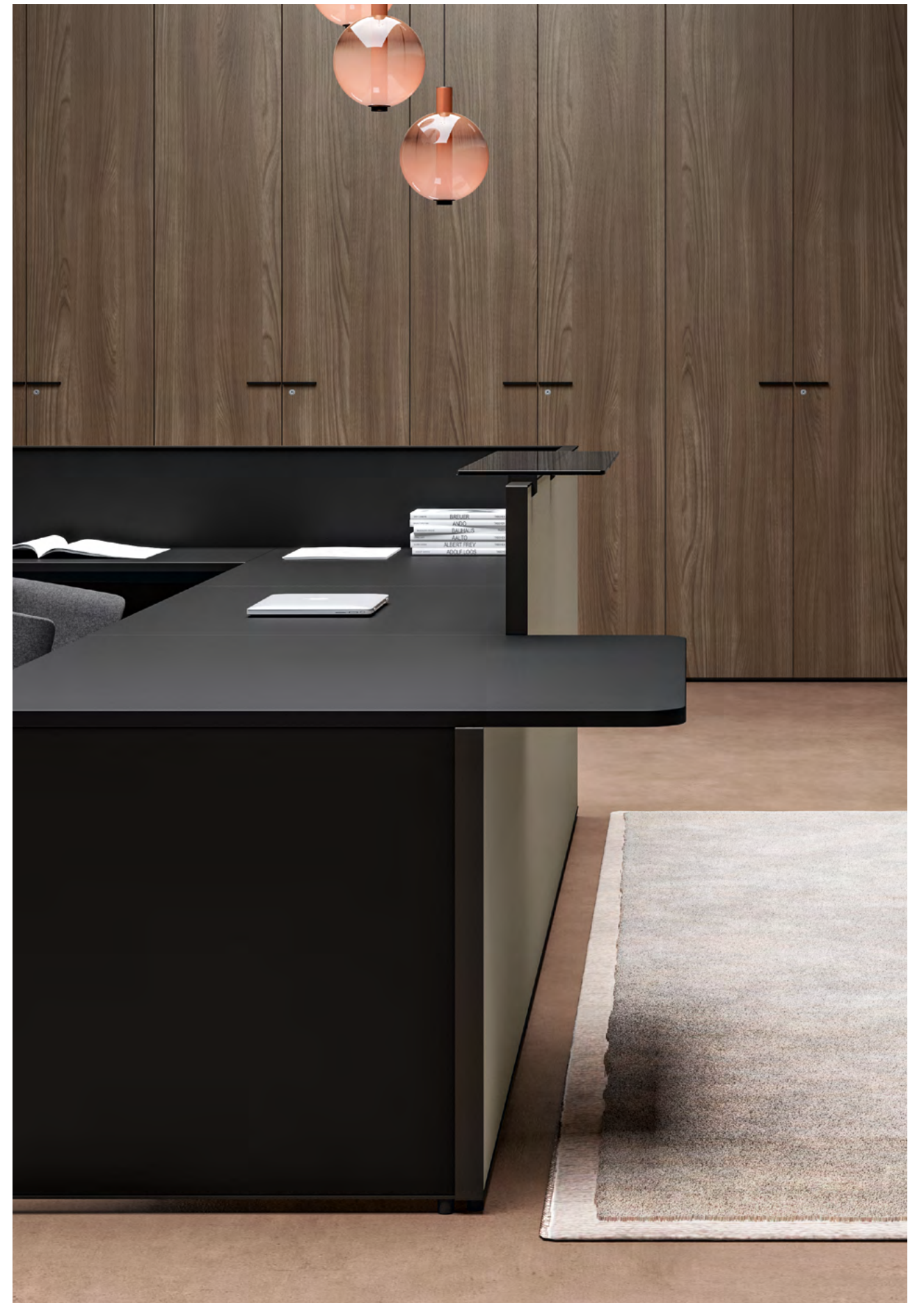

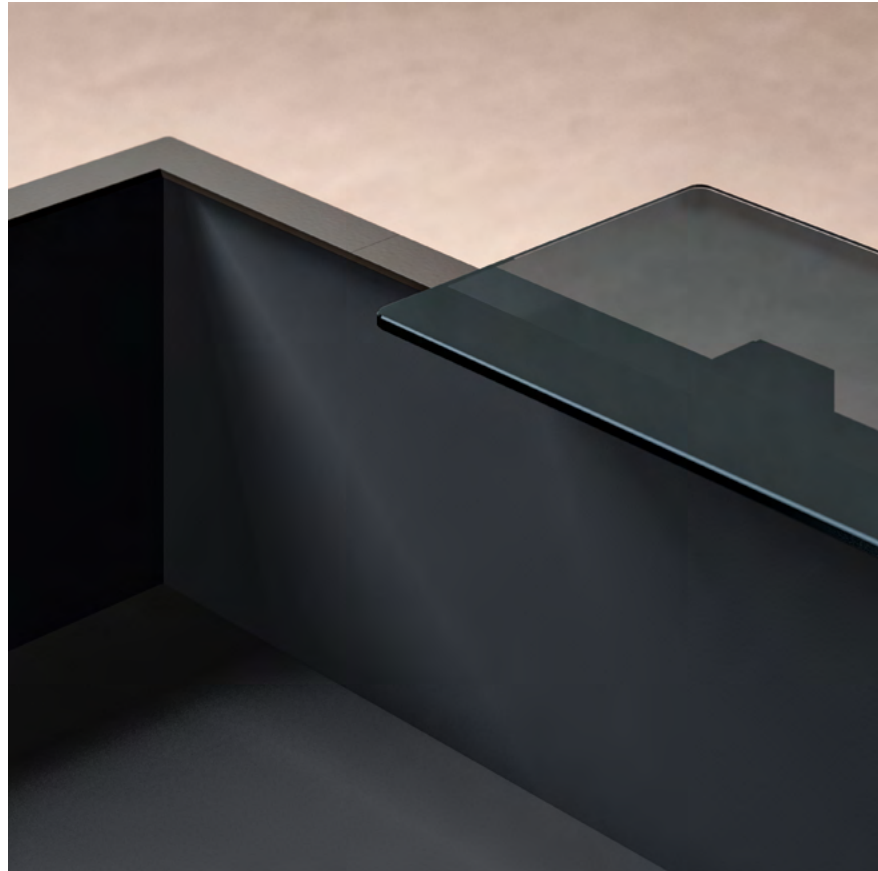













<p>h 102,3 d 82,7</p> <p>w 81÷181</p>	<p>h 102,3 d 83,2</p> <p>w 201÷361</p>	<p>h 102,3 d 83,2</p> <p>w 125,4÷205,4</p>	<p>h 102,3 d 83,2</p> <p>w 205,4÷405,4</p>
<p>h 102,3 d 82,7</p> <p>w 122,7÷202,7</p>	<p>h 102,3 d 62,7-82,7</p> <p>w 163,2÷203,2</p>	<p>h 102,3 d 60,5</p> <p>w 140,5÷180,5</p>	<p>h 102,3 d 60,5</p> <p>w 4,1</p>
<p>h 102,3 d 82,7</p> <p>w 80,5÷180,5</p>	<p>h 102,3 d 112,5-132,5</p> <p>w 80÷120</p>	<p>h 71,8 d 17</p> <p>w 80,5÷120,5</p>	<p>h 71,8 d 17</p> <p>w 64,6</p>
<p>h 0,3 d 28</p> <p>w 80-120</p> <p>metallo metal métal metal metal</p>	<p>h 0,8 d 28</p> <p>w 80-120</p> <p>vetro glass verre Glas vidrio</p>	<p>h 1,8 d 28</p> <p>w 80-120</p> <p>melaminico melamine mélamine melamin melamina</p>	

measure in cm • measurements in cm • mesures en cm • Maße in cm • medidas en cm

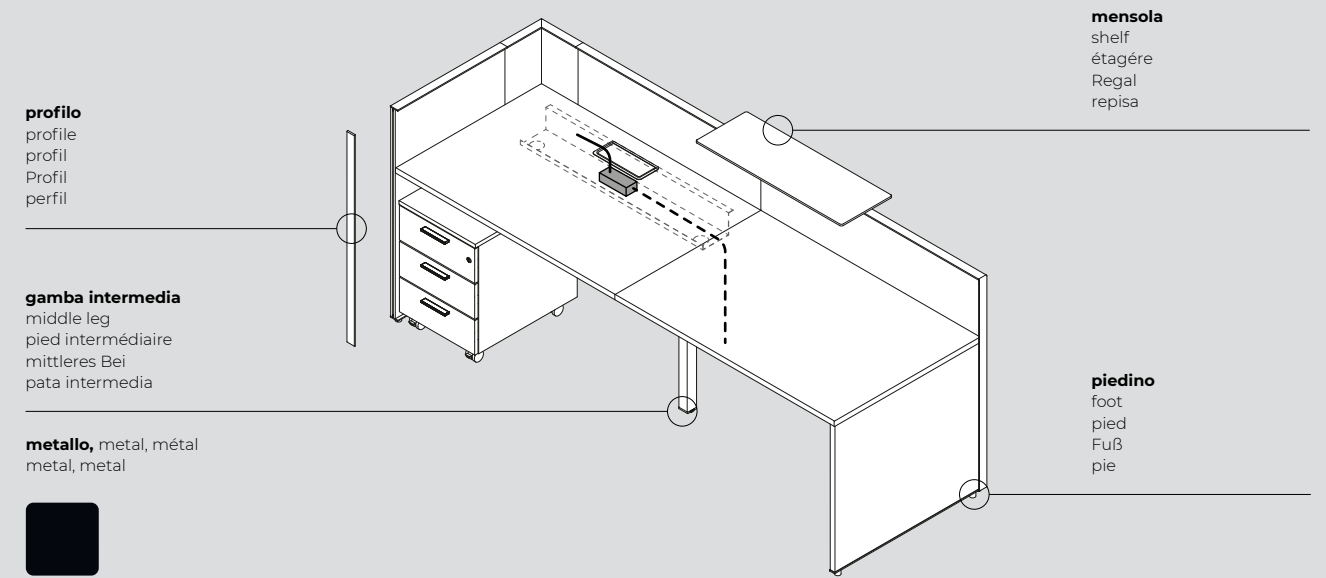

piano e gamba
worktop and leg
plateau et piètement
Tischplatte und Wange
tapa y pata

melaminico, melamine, mélamine,
melamin, melamina



profili e piedini
profiles and feet
profils et pieds
Rahmen und Füße
perfiles y pies

metallo, metal, métal, metal, metal



frontali
fronts
façade
Fronten
Frontal

melaminico, melamine, mélamine,
melamin, melamina



frontali (solo esterno)
fronts (external only)
façade (externe uniquement)
Fronten (Nur extern)
Frontal (solo externo)

laccato opaco, lacquered matt, lacqué mat,
matt lackiert, lacado mate

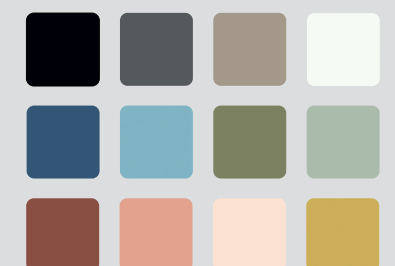

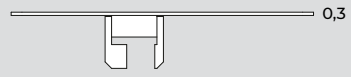

metallo epox
metal epoxy
epoxy métal
epoxy metal
epoxidico metal

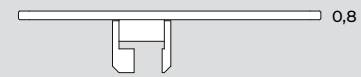

vetro fumé,
transparent smoke grey glass
verre fumé
rauchglas
vidrio ahumado



melaminico
melamine
mélamine
melamin
melamina

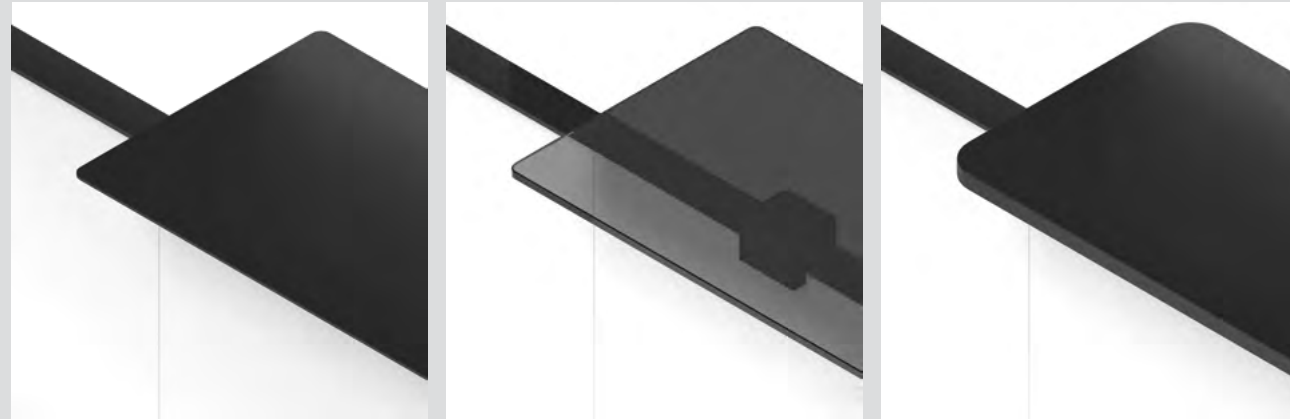

highlights

profilo
profile
profil
Profil
perfil



piedino
foot
pied
Fuß
pie

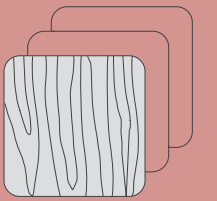

FINITURE E COLORI
finishing and colors
finitions et couleurs
Oberfläche und farben
acabados y colores



melaminico • melamine • mélamine • melamin • melamina

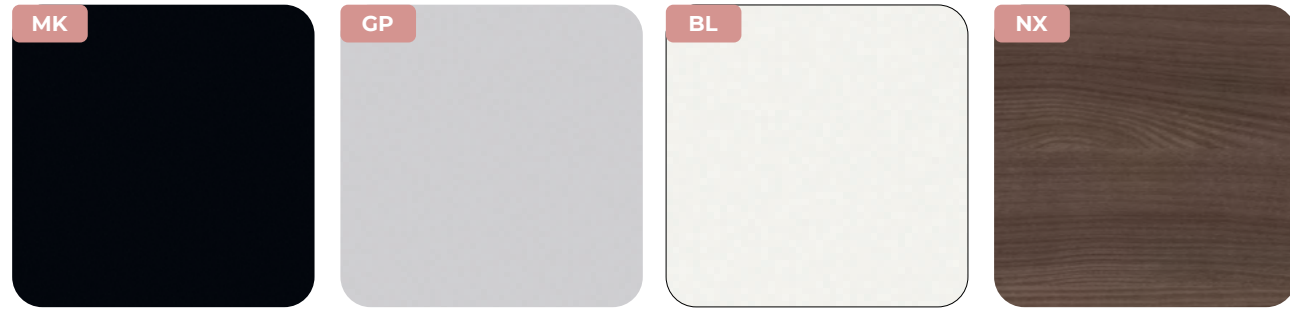

nero
black
noir
schwarz
negro

grigio perla
pearl-grey
gris perle
perlgrau
gris perla

bianco
white
blanc
weiß
blanco

noce Lux
walnut Lux
noyer Lux
lux Nussbaum
nogal Lux

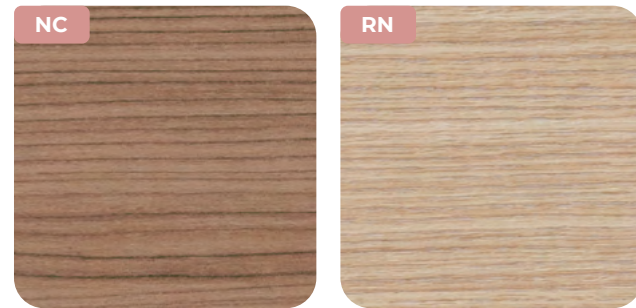

noce canaletto
canaletto walnut
noyer canaletto
Canaletto Nussbaum
nogal canaletto

rovere naturale
natural oak
chêne naturel
Natur Eiche
roble natural

vetro temperato • tempered glass • verre trempé • sicherheitsglas • vidrio templado



metallo • metal • métal • metall • metal

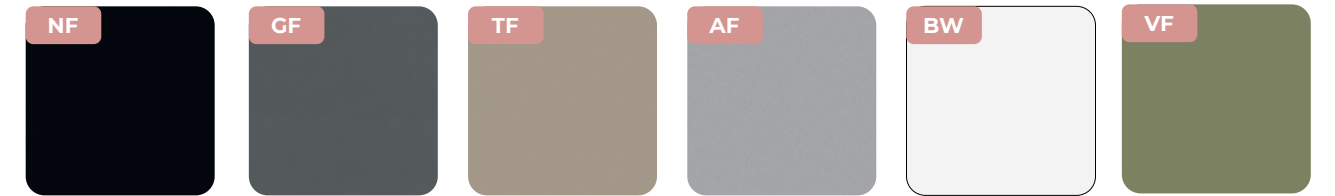

nero
black
noir
schwarz
negro

grigio titanio
titanium grey
gris titane
titangrau
gris titanio

tortora
turtledove
tourterelle
taubengrau
törtola

epox alluminio
silver epoxy
epoxy aluminium
epoxy aluminium
epoxidico aluminio

bianco
white
blanc
weiß
blanco

oliva
olive
olive
olive
oliva



terracotta
terracotta
terre cuite
terrakotta
terracota

grigio ombra
shadow grey
gris ombre
vulcanschwarz
sombra gris

rame rosa
pink copper
cuivre rose
kupfer-Pink
cobre rosa

laccato opaco • lacquered matt • laqué mat • matt lackiert • lacado mate

