

Mito

technische Beschreibung

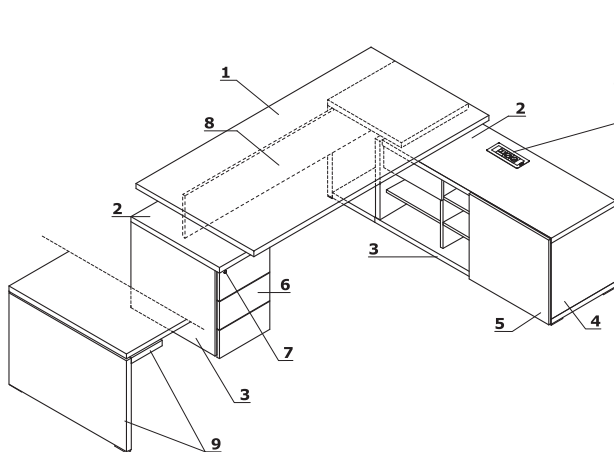

Schreibtische



1. **Platte** - Melaminplatte, 38 mm, Umleimer ABS
2. **Oberplatte** - Melaminplatte 38 mm, Umleimer ABS
3. **Boden** - Melaminplatte 38 mm, Umleimer ABS
4. **Korpus** - Melaminplatte 18 mm, Umleimer ABS
5. **Schiebetür** - Melaminplatte 18 mm, Umleimer ABS
6. **Front** - Melaminplatte 18 mm, Umleimer ABS
7. **Zentralverschluss** - Klappschlüssel
8. **Verbindungselement** - Melaminplatte 18 mm, Umleimer ABS
9. **Wangenfuß** - HPL Hochglanz 38 mm
10. **Mediaport S91E** - OPTION GEGEN AUFPREIS - 2x 230V, 2x RJ45

Managerschränke

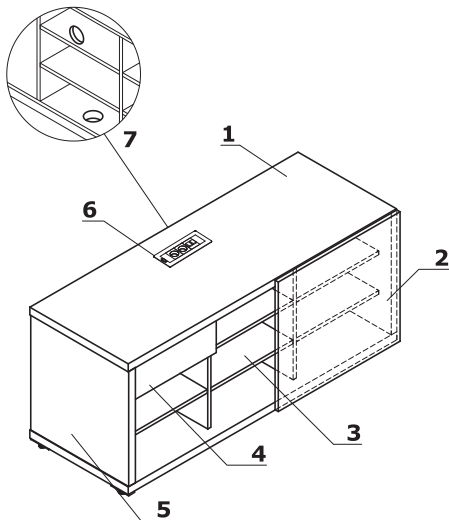

1. **Oberplatte** - Melaminplatte 38 mm, Umleimer ABS
2. **Front** - Melaminplatte 18 mm, Umleimer ABS
3. **Innenseite** - Melaminplatte 18 mm
4. **Schublade** - Melaminplatte 18 mm, Umleimer ABS, Patentschloss; Möglichkeit, Lage der Schublade zu ändern
5. **Seiten** - Melaminplatte 38 mm, Umleimer ABS
6. **Mediaport S91E** - OPTION GEGEN AUFPREIS - 2x 230V, 2x Rj45
7. **Kabeldurchlässe** - Ø80 mm

Beispielkonfigurationen

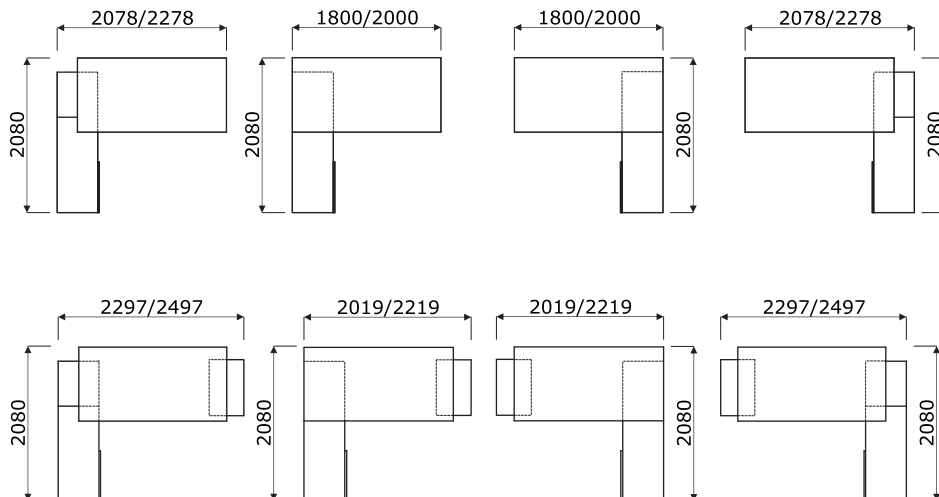

Schreibtische mit elektrischer Höhenverstellung und Managerschrank

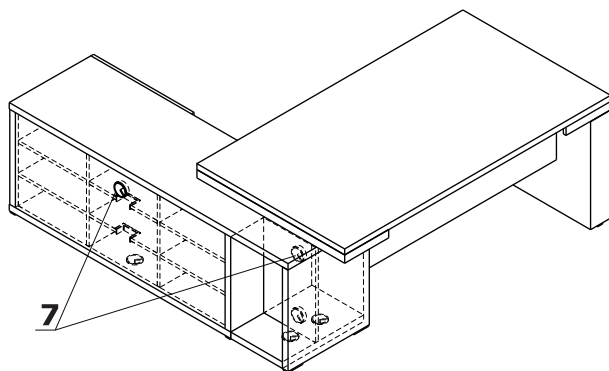
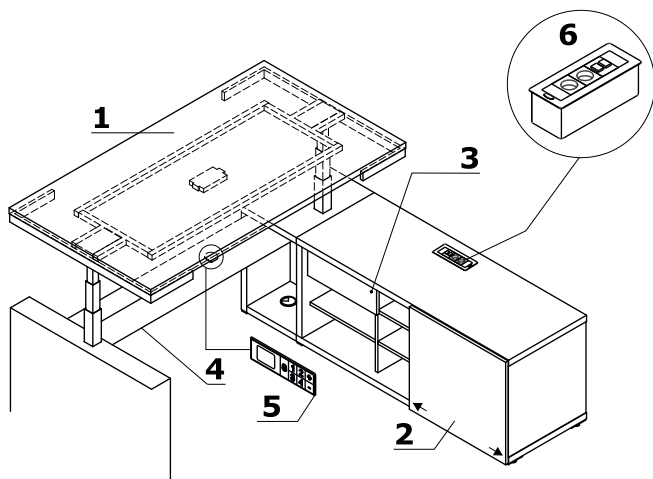

1. **Platte** - Melaminplatte, 38 mm, Umleimer ABS
2. **Schiebetür** - Melaminplatte 18 mm, Umleimer ABS
3. **Schublade** - Melaminplatte 18 mm, Umleimer ABS - Möglichkeit, Lage der Schublade zu ändern
4. **Elektrische Stellage** - Metall pulverbeschichtet, Tragkraft 100 kg, Teleskopsäule - Profil: 60/60, 50/50, 40/40
5. **Steuerung:**
 - A - Steuerung mit 4 Höhen-Speicherpositionen; die Möglichkeit, die Empfindlichkeit des Antikollisionssystems innerhalb von 3 Stufen zu ändern: Niedrig, Mittel, Hoch
 - B - OPTION GEGEN AUFPREIS fürs Panel A - Bluetooth-Modul - Steuerung über die MDD Desk BT-App (zum Download über Google Play oder App Store). Die App verfügt über eine Zeitintervallfunktion, die den Benutzer über die Notwendigkeit informiert, die Position des Körpers zu ändern (vom Sitzen zum Stehen oder vom Stehen zum Sitzen).
6. **Mediaport S91E** - OPTION GEGEN AUFPREIS - 2x 230V, 2x Rj45
7. **Kabeldurchlässe**

Technische Beschreibung der Stellage:

- **Hubgeschwindigkeit** - 40 mm/s, Super Soft - Start - Stop
- **Antrieb** - 2 Motoren (synchroner Antrieb); Steuerung per Microprozessor
- **Schutz** - ISP - Intelligent System Protectio
- **Normen** - EN 527-2
- **Richtlinien** - 206/95EC, UI508 1999, UL 1004 R7 06, WE DC 2004/108WE
- **Netzspannung** - 230V, Leistung 300W, Stand-by-Verbrauch 0.3W

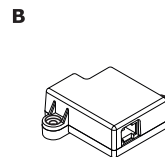
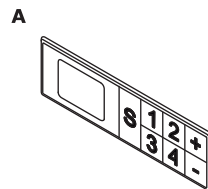

Schränke mit Hängeregisterschubladen

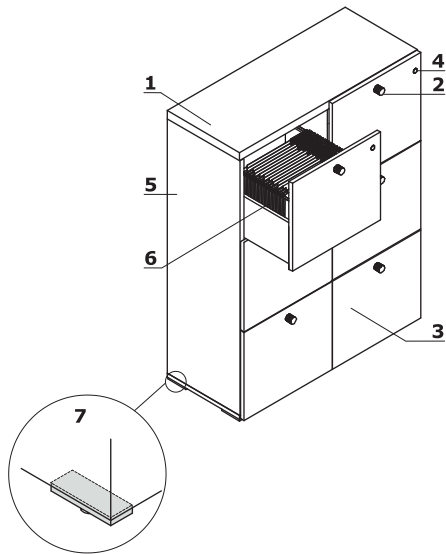

1. Oberplatte - Melaminplatte 38 mm, Umleimer ABS
2. Griffe - Aluminium
3. HPL - Front in Hochglanz
4. Zentralverschluss - Klappschlüssel
5. Seiten - Melaminplatte 18 mm, Umleimer ABS
6. Hängeregisterschublade - Melaminplatte 18 mm mit Boden, Kugelführungen, Belastung max. 45kg, Auszug 100%
7. Höhenverstellung - 5 mm

Schiebetürenschränke

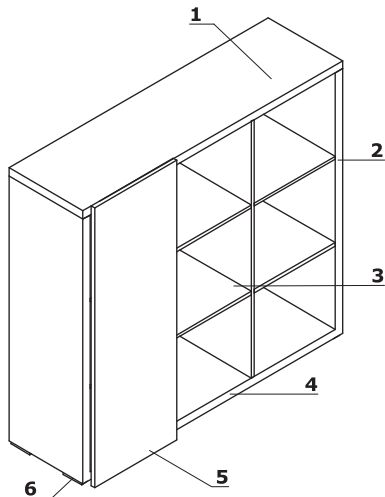

1. Oberplatte - Melaminplatte 38 mm, Umleimer ABS
2. Seiten - Melaminplatte 38 mm, Umleimer ABS
3. Innenseite - Melaminplatte 18 mm
4. Boden - Melaminplatte 38 mm, Umleimer ABS
5. Schiebetür - HPL-Platte 18 mm, Umleimer ABS
6. Höhenverstellung - 5 mm

Schränke mit Schiebetür MIT7 / MIT18

Schränke und Regale

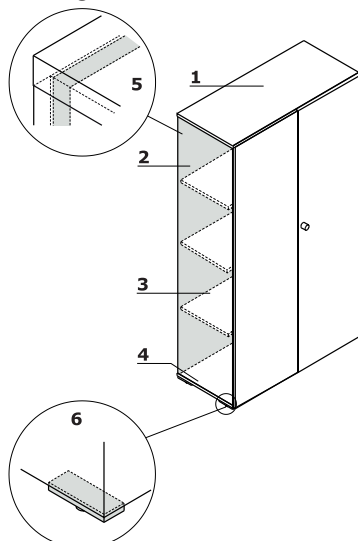

1. Oberplatte - Melaminplatte 18 mm, Umleimer ABS
2. Seiten - Melaminplatte 18 mm, Umleimer ABS
3. Fachboden - Melaminplatte 18 mm, Schutz vor einem zufälligen Ausfahren, Umleimer ABS
4. Boden - Melaminplatte 18 mm, Umleimer ABS
5. Rückwand - Melaminplatte 18 mm, Umleimer ABS
6. Höhenverstellung - 5 mm
7. Stangenschloss beim Türknäuf

Konferenztische mit Tellerfuß

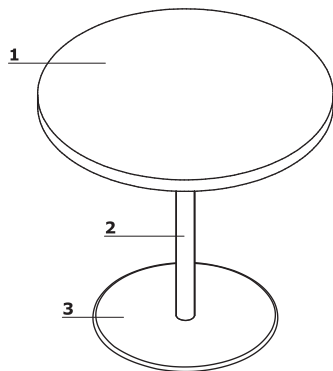

1. **Platte** - Melaminplatte, 38 mm, Umleimer ABS
2. **Säule** - Metall, pulverbeschichtet
3. **Tellerfuß** - Edelstahl INOX, pulverbeschichtet

Konferenztische mit plattenfüßen

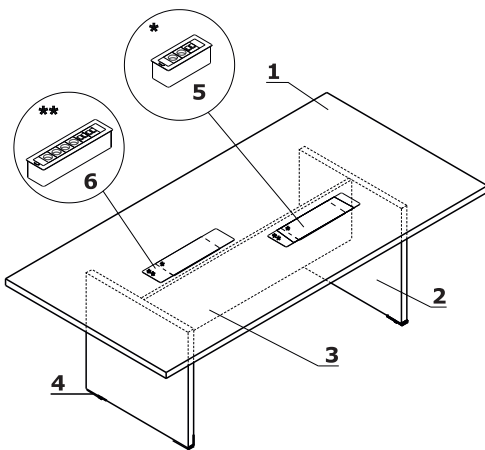

1. **Platte** - Melaminplatte, 38 mm, Umleimer ABS
2. **Wangenuß** - HPL Hochglanz 38 mm
3. **Verbindungselement** - Melaminplatte 18 mm, Umleimer ABS
4. **Höhenverstellung** - 5 mm
5. **Mediaport S91E** - OPTION GEGEN AUFPREIS - 2x 230V, 2x RJ45
6. **Mediaport S92E** - OPTION GEGEN AUFPREIS - 4x 230V, 4x RJ45

Rollcontainer, grifflos (MIT120, MIT130)

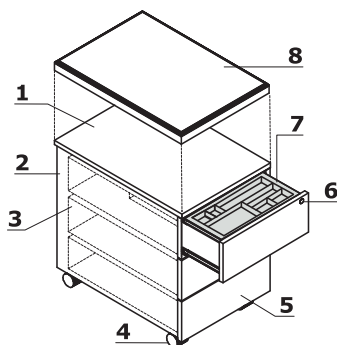

1. **Oberplatte** - Melaminplatte 18 mm, Umleimer ABS
2. **Korpus** - Melaminplatte 18 mm, Umleimer ABS
3. **Plattenschubladen** - Kugelführung mit einer Belastung von max. 25kg, Auszug 100%, Blockierung gegen das gleichzeitige Ausfahren von mehreren Schublade
4. **Räder** - Ø50 mm, 2 mit Bremsen
5. **Front** - Melaminplatte 18 mm, Umleimer ABS
6. **Zentralverschluss** - Klappschlüssel
7. **Materialeinsatz** - Kunststoff, Farbe: schwarz
8. **Optionales Kissen SKP13** - für Container, Belastung max. 120 kg, separat zu bestellen

HINWEISE - Sitzen auf Container erst nach der Montage des Sitzkissens möglich (SKP13); Container mit Sitzkissen ist nur zum Sitzen vorgesehen. Wenn Sie sich im Sitzen auf einem Container bewegen, können die Rollen beschädigt werden.

Rollcontainer, grifflos (SLD12HT, SLD13HT)

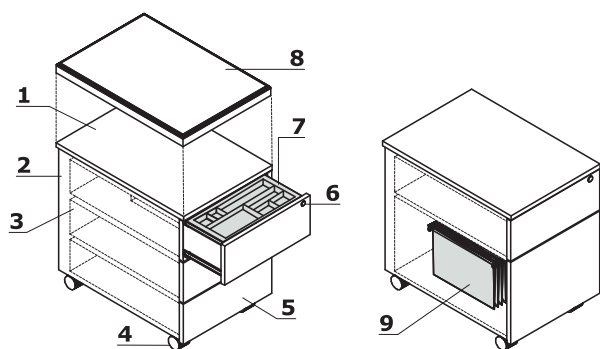

1. **Oberplatte** - Melaminplatte 18 mm, beschichtet mit HPL Hochglanz
2. **Korpus** - Melaminplatte 18 mm, Umleimer ABS
3. **Metallschubladen** - Rollenführung, Belastung max. 25 kg, Auszug 80%, Auszugssperre; OPTION GEGEN AUFPREIS - Kugelführungen, End-Selbsteinzug
4. **Räder** - Ø50 mm, 2 mit Bremsen
5. **Front** - Melaminplatte 18 mm, beschichtet mit HPL Hochglanz, Umleimer ABS
6. **Zentralverschluss** - Klappschlüssel
7. **Materialeinsatz** - Kunststoff, Farbe: schwarz
8. **Optionales Kissen SKP13** - für Container, Belastung max. 120 kg, separat zu bestellen
9. **Hängeregisterschublade** - Kugelführungen, Belastung max. 30 kg, Auszug 100%, A4-Ordner können parallel und vertikal zur Front platziert werden

HINWEISE - Sitzen auf Container erst nach der Montage des Sitzkissens möglich (SKP13); Container mit Sitzkissen ist nur zum Sitzen vorgesehen.
Wenn Sie sich im Sitzen auf einem Container bewegen, können die Rollen beschädigt werden.

Beispiellage von mediaporten

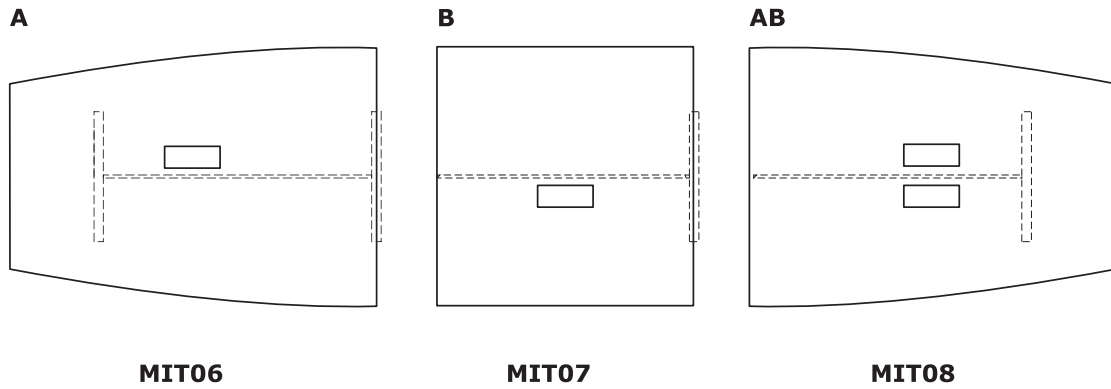

Schreibtische *

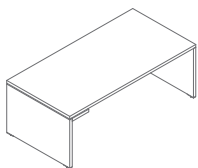

MIT3
2000 / 1000 / 740
113.05 kg

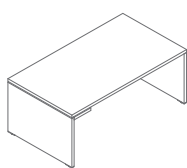

MIT4
1800 / 1000 / 740
109.95 kg

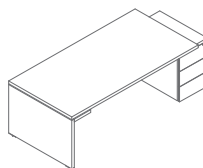

MIT3KD
2219 / 1000 / 740
162 kg

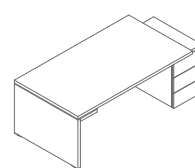

MIT4KD
2019 / 1000 / 740
153.55 kg

Ansatz Tisch für schreibtische *

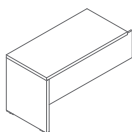

MIT12
1200 / 600 / 740
37.4 kg

Schreibtische mit Managerschrank *

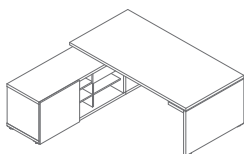

MIT1
2000-2278 / 2080 / 740
233.75 kg

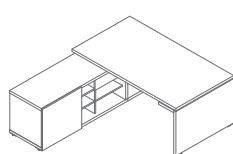

MIT2
1800-2078 / 2080 / 740
230.65 kg

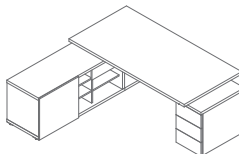

MIT1KD
2219-2497 / 2080 / 740
273.3 kg

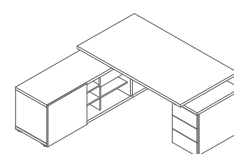

MIT2KD
2019-2297 / 2080 / 740
264.85 kg

Schreibtische mit elektrischer Höhenverstellung und Managerschrank *

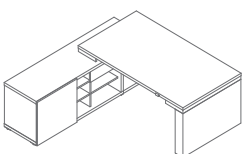

MIT1RL
2190 / 2080 / 1300-760
350.7 kg

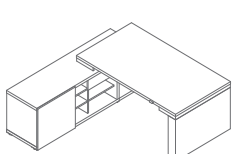

MIT2RL
1990 / 2080 / 1300-760
342.1 kg

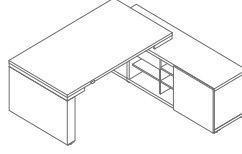

MIT1RP
2190 / 2080 / 1300-760
356.75 kg

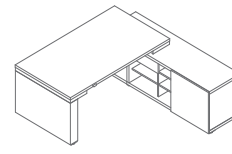

MIT2RP
1990 / 2080 / 1300-760
348.15 kg

* Abmessungen in Millimetern: Breite x Tiefe x Höhe

Rollcontainer, grifflos *



MIT130
428 / 600 / 586
35 kg



SLD13HT
416 / 600 / 587
23 kg



MIT120
428 / 600 / 586
32 kg

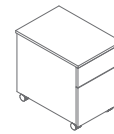

SLD12HT
416 / 600 / 587
23 kg

Tische und Konferenztische *



MIT10
800 / 800 / 740
34.2 kg



MIT17
1200 / 1200 / 740
59.4 kg

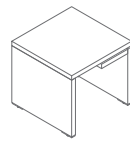

MIT23
600 / 600 / 550
32.2 kg

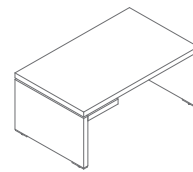

MIT9
1000 / 600 / 450
37.2 kg

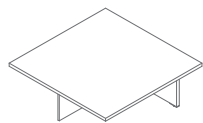

MIT07
1400 / 1400 / 740
64.45 kg

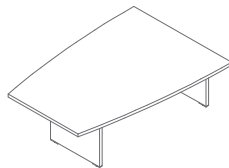

MIT06
2000 / 1000-1400 / 740
98.95 kg

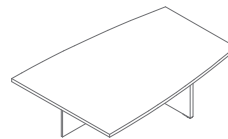

MIT08
2000 / 1000-1400 / 740
87.3 kg

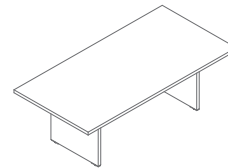

MIT11
2200 / 1100 / 740
102.15 kg

Konferenztische - fertige Konfigurationen *

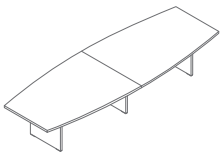

MIT24
4000 / 1400-1000 / 740
182.45 kg

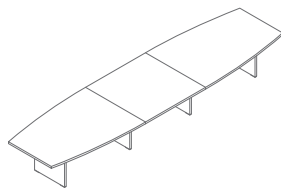

MIT25
5400 / 1400-1000 / 740
245 kg

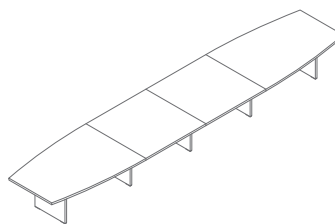

MIT26
6800 / 1400-1000 / 740
307.55 kg

* Abmessungen in Millimetern: Breite x Tiefe x Höhe

Schränke mit HPL-Front *

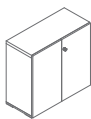

MIT21
916 / 418 / 879
58.45 kg

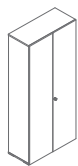

MIT19
916 / 418 / 2077
113.75 kg

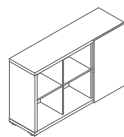

MIT18
1400 / 422 / 879
82.2 kg

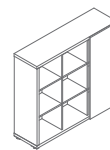

MIT7
1400 / 422 / 1280
108.7 kg

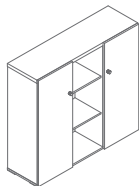

MIT20
1363 / 418 / 1280
101.5 kg

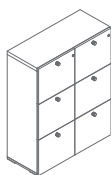

MIT22
980 / 418 / 1280
110.25 kg

Schränke *

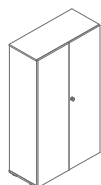

MIT8
916 / 418 / 1661
84.15 kg

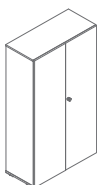

MIT15
916 / 418 / 1661
89.2 kg

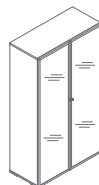

MIT16
916 / 418 / 1661
90.3 kg

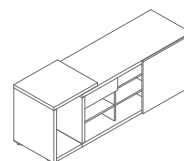

MIT5
1887 / 572 / 690
141.3 kg

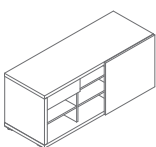

MIT6
1500 / 572 / 652
115.3 kg

* Abmessungen in Millimetern: Breite x Tiefe x Höhe

Schreibtische - mit Elementen in matter Ausführung *

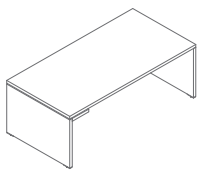

MIT3L
2000 / 1000 / 740
111 kg

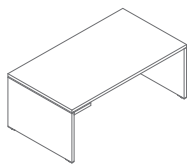

MIT4L
1800 / 1000 / 740
107.9 kg

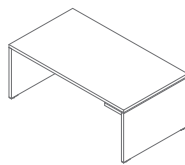

MIT3P
2000 / 1000 / 740
109.55 kg

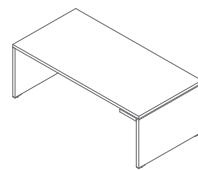

MIT4P
1800 / 1000 / 740
106.45 kg

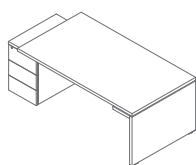

MIT3KDL
2219 / 1000 / 740
161.7 kg

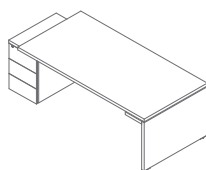

MIT4KDL
2019 / 1000 / 740
153.25 kg

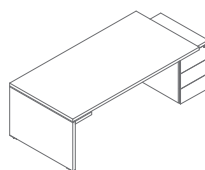

MIT3KDP
2219 / 1000 / 740
161.95 kg

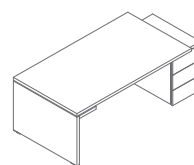

MIT4KDP
2019 / 1000 / 740
153.5 kg

Ansattztisch für schreibtische - mit Elementen in matter Ausführung *

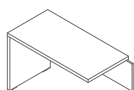

MIT12L
1200 / 600 / 740
32.4 kg

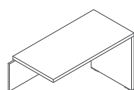

MIT12P
1200 / 600 / 740
32.65 kg

Schreibtische mit Managerschrank - mit Elementen in matter Ausführung *

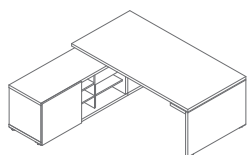

MIT1L
2000-2278 / 2080 / 740
232.95 kg

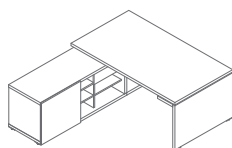

MIT2L
1800-2078 / 2080 / 740
229.85 kg

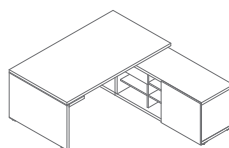

MIT1P
2000-2278 / 2080 / 740
233.2 kg

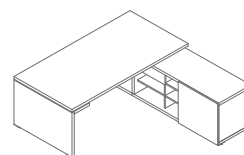

MIT2P
1800-2078 / 2080 / 740
230.1 kg

* Abmessungen in Millimetern: Breite x Tiefe x Höhe

Schreibtische mit Managerschrank - mit Elementen in matter Ausführung *

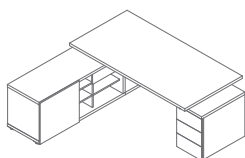

MIT1KDL
2219-2497 / 2080 / 740
272.8 kg

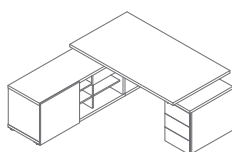

MIT2KDL
2019-2297 / 2080 / 740
264.35 kg

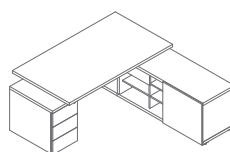

MIT1KDP
2219-2497 / 2080 / 740
272.8 kg

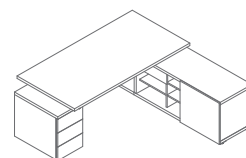

MIT2KDP
2019-2297 / 2080 / 740
264.35 kg

Schreibtische mit elektrischer Höhenverstellung und Managerschrank - mit Elementen in matter Ausführung *

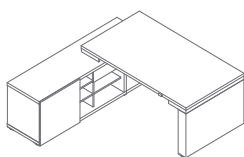

MIT27RL
2190 / 2080 / 1300-760
349.25 kg

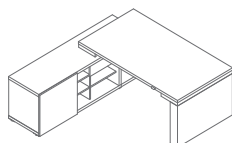

MIT28RL
1990 / 2080 / 1300-760
324.7 kg

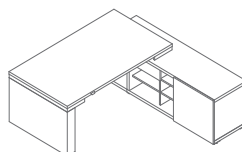

MIT27RP
2190 / 2080 / 1300-760
336.95 kg

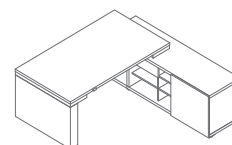

MIT28RP
1990 / 2080 / 1300-760
312.4 kg

Rollcontainer, grifflos - mit Elementen in matter Ausführung *

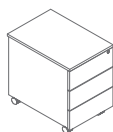

SLD13HTM
416 / 600 / 587
23 kg

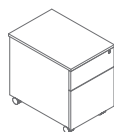

SLD12HTM
416 / 600 / 587
23 kg

Tische und Konferenztische - mit Elementen in matter Ausführung *

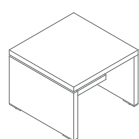

MIT29
600 / 600 / 550
31.05 kg

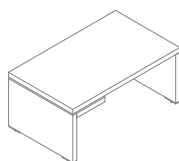

MIT30
1000 / 600 / 450
36.9 kg

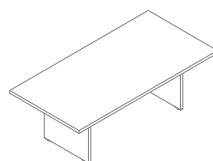

MIT45
2200 / 1100 / 740
102.35 kg

* Abmessungen in Millimetern: Breite x Tiefe x Höhe

Schränke - mit Elementen in matter Ausführung *

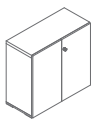

MIT31
916 / 418 / 879
98 kg

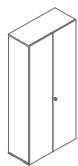

MIT32
916 / 418 / 2077
107.25 kg

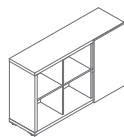

MIT33
1400 / 422 / 879
147.7 kg

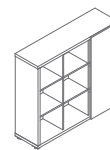

MIT34
1400 / 422 / 1280
97.3 kg

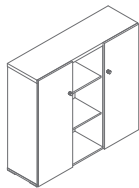

MIT38
1363 / 418 / 1280
98.65 kg

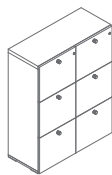

MIT35
980 / 418 / 1280
174 kg

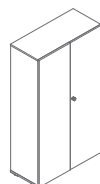

MIT39
916 / 418 / 1661
84.15 kg

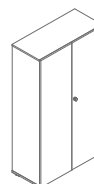

MIT40
916 / 418 / 1661
89.2 kg

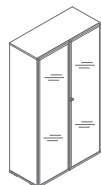

MIT41
916 / 418 / 1661
90.3 kg

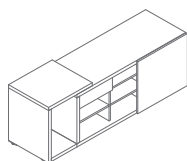

MIT36
1887 / 572 / 690
139.2 kg

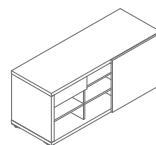

MIT37
1500 / 572 / 652
113.7 kg

* Abmessungen in Millimetern: Breite x Tiefe x Höhe

Schreibtische - Tischplatte mit Antifingerprint-Beschichtung *

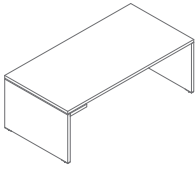

MITF3L
2000 / 1000 / 740
100.3 kg

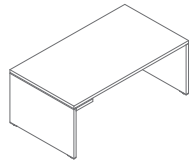

MITF4L
1800 / 1000 / 740
98 kg

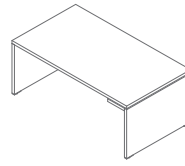

MITF3P
2000 / 1000 / 740
98.95 kg

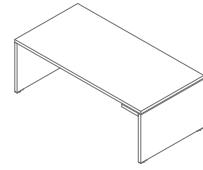

MIT4FP
1800 / 1000 / 740
96.55 kg

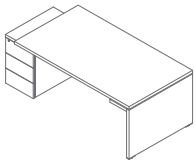

MITF3KDL
2219 / 1000 / 740
150.3 kg

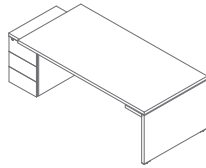

MITF4KDL
2019 / 1000 / 740
145.3 kg

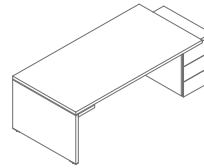

MITF3KDP
2219 / 1000 / 740
150.55 kg

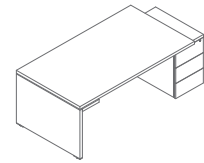

MITF4KDP
2019 / 1000 / 740
145.55 kg

Ansattztisch für schreibtische - Tischplatte mit Antifingerprint-Beschichtung *

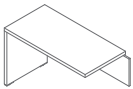

MITF12L
1200 / 600 / 740
32.4 kg

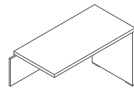

MITF12P
1200 / 600 / 740
32.4 kg

Schreibtische mit Managerschrank - Tischplatte mit Antifingerprint-Beschichtung *

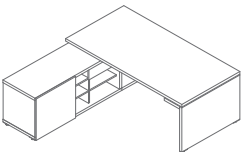

MITF1L
2000-2278 / 2080 / 740
242.65 kg

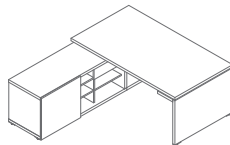

MITF2L
1800-2078 / 2080 / 740
240.35 kg

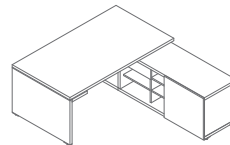

MITF1P
2000-2278 / 2080 / 740
242.9 kg

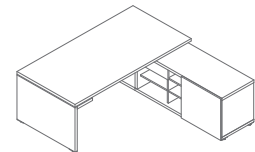

MITF2P
1800-2078 / 2080 / 740
240.6 kg

* Abmessungen in Millimetern: Breite x Tiefe x Höhe

Schreibtische mit Managerschrank - Tischplatte mit Antifingerprint-Beschichtung *

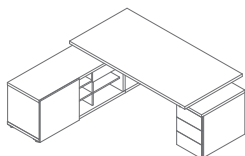

MITF1KDL
2219-2497 / 2080 / 740
281.9 kg

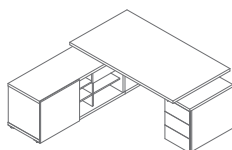

MITF2KDL
2019-2297 / 2080 / 740
276.8 kg

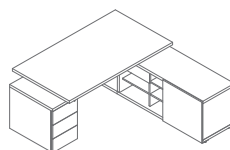

MITF1KDP
2219-2497 / 2080 / 740
281.8 kg

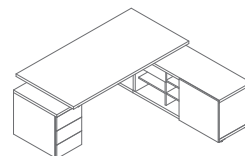

MITF2KDP
2019-2297 / 2080 / 740
276.8 kg

Schreibtische mit elektrischer Höhenverstellung und Managerschrank - Tischplatte mit Antifingerprint-Beschichtung*

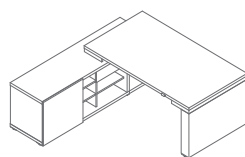

MITF27RL
2190 / 2080 / 1300-760
445.95 kg

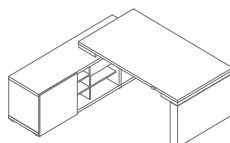

MITF28RL
1990 / 2080 / 1300-760
436.4 kg

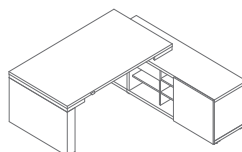

MITF27RP
2190 / 2080 / 1300-760
434.75kg

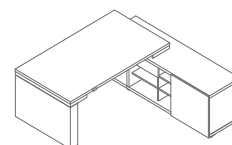

MITF28RP
1990 / 2080 / 1300-760
425.2 kg

Tische und Konferenztische - Tischplatte mit Antifingerprint-Beschichtung *

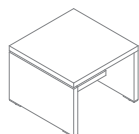

MITF29
600 / 600 / 550
52.4 kg

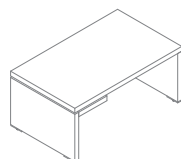

MITF30
1000 / 600 / 450
58 kg

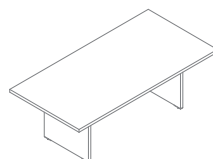

MITF45
2200 / 1100 / 740
348.2 kg

Zubehör *



S100
416 / 600 / 50
0 kg

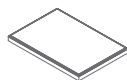

SKP13
400 / 600 / 52
2.7 kg

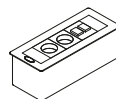

S91E
267 / 110 / 93
1.9 kg

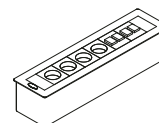

S92E
426 / 110 / 93
2.75 kg

* Abmessungen in Millimetern: Breite x Tiefe x Höhe

Schreibtische, MIT11

Platte



172 Bernstein
Eiche



173 Robinie

Fuß HPL



73 Weiß Glanz



101 Schwarz Glanz



155 Anthrazit
Glanz

Tische mit Tellerfuß

Platte



172 Bernstein
Eiche



173 Robinie

Säule



M009 Aluminium
halbmatt RAL9006



M015 Weiß
halbmatt RAL9010



M115 Schwarz
halbmatt RAL9005



M154 Anthrazit
halbmatt RAL 7043

Tellerfuß



25 Poliertes
Aluminium

MIT5 - Ansatzelement



73 Weiß Glanz



101 Schwarz Glanz



155 Anthrazit
Glanz

Schränke mit HPL-Front

Oberplatte, Korpus, Sockel,



73 Weiß Glanz



101 Schwarz Glanz



155 Anthrazit
Glanz

Rollcontainer, grifflos (SLD12HT, SLD13HT)

Oberplatte, Korpus, Sockel



67 Weiß Pastell



08 Schwarz

Rollcontainer, grifflos (SLD12HT, SLD13HT)

Front



174 Beige matt



175 Trüffel Farbe
matt



176 Rot matt



177 Grau matt



178 Avocado matt



179 Flaschengrün
matt



180 Dunkelblau
matt



184 Himmelblau
matt

Rollcontainer, grifflos (MIT120, MIT130)

Oberplatte, Front



172 Bernstein
Eiche



173 Robinie

Korpus



Grau



Schwarz

Platte - Schreibtische - mit Elementen in matter Ausführung, MIT29, MIT30, MIT45



172 Bernstein
Eiche



173 Robinie

Basis



186 Schwarz matt
RAL9005



188 Weiß matt
RAL9010

MIT36



186 Schwarz matt
RAL9005



188 Weiß matt
RAL9010

Schränke - mit Elementen in matter Ausführung

Oberplatte, Korpus, Sockel



172 Bernstein
Eiche

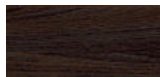

173 Robinie



186 Schwarz matt
RAL9005

Front



186 Schwarz matt
RAL9005



188 Weiß matt
RAL9010

Rollcontainer, grifflos



186 Schwarz matt
RAL9005



188 Weiß matt
RAL9010

Schreibtische - Tischplatte mit Antifingerprint-Beschichtung, MITF29, MITF30, MITF45

Platte



183 Fenix schwarz
matt RAL9005

Fuß



172 Bernstein
Eiche



173 Robinie



186 Schwarz matt
RAL9005

SKP13

Stoff Nemo

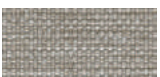

NE-1 Beige

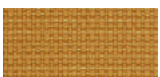

NE-2 Gelb

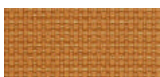

NE-3 Orange



NE-5 Rot



NE-9 Grün



NE-10 Grau

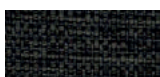

NE-14 Anthrazit



NE-15 Marineblau



NE-16 Schwarz



NE-17 Blau

Technische Daten:

Material	polyester 100%
Stoffgewicht	366g/m ²
Scheuetrouren	PN_EN ISO 12947 - 2:2 100,000
Pilling (Knötchenbildung)	Skala 1-8, max. 8, PN-EN ISO 105 - B02 (3-4)
Lichteinheit	Skala 1-5, max. 5, PN-EN 1021 - 2, PN-EN 1021 - 1
Reibechtheit nass / trocken	Skala 1-5, max. 5, EN ISO 105x12 (nass/trocken (4-5))